

# Zahnriemenscheiben

---

Zahnriemenscheiben T5

Zahnriemenscheiben T10

Zahnriemenscheiben AT5

Zahnriemenscheiben AT10

Zahnriemenscheiben HTD 5M

Zahnriemenscheiben HTD 8M

Zahnriemenscheiben HTD 14M

Sonderanfertigungen nach Zeichnung sowie  
Standardteile einbaufertig bearbeitet,  
auf Wunsch mit Wärme- und/oder Oberflächenbehandlung

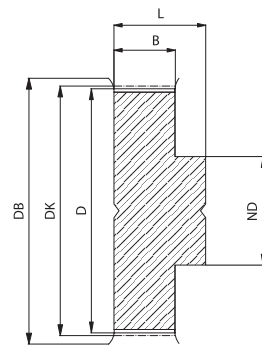

Typ 6F

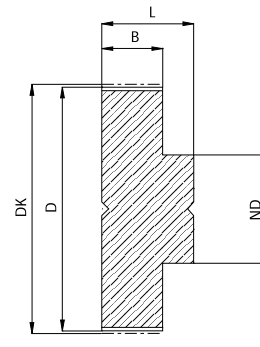

Typ 6

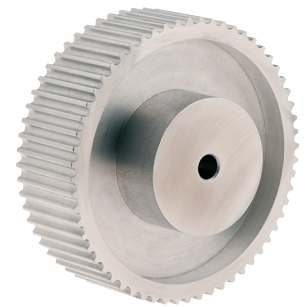

## Zahnriemenscheiben T5

G&G-Best.-Nr.	Typ	ZZ	Ausführung	ZRB*	B	L	DK	D	DB	ND
820-001-0010	21 T5/10-2	10	6F	10.00	15.00	21.00	15,91	15,05	19.50	8.00
820-001-0012	21 T5/12-2	12	6F	10.00	15.00	21.00	19.10	18,25	23.00	10.00
820-001-0014	21 T5/14-2	14	6F	10.00	15.00	21.00	22,28	21,45	25.00	13.00
820-001-0015	21 T5/15-2	15	6F	10.00	15.00	21.00	23,87	23,05	28.00	16.00
820-001-0016	21 T5/16-2	16	6F	10.00	15.00	21.00	25,47	24,60	32.00	18.00
820-001-0018	21 T5/18-2	18	6F	10.00	15.00	21.00	28,65	27,80	32.00	19.00
820-001-0019	21 T5/19-2	19	6F	10.00	15.00	21.00	30,24	29,40	36.00	22.00
820-001-0020	21 T5/20-2	20	6F	10.00	15.00	21.00	31,83	31,00	36.00	23.00
820-001-0022	21 T5/22-2	22	6F	10.00	15.00	21.00	35,01	34,25	38.00	24.00
820-001-0024	21 T5/24-2	24	6F	10.00	15.00	21.00	38,19	37,40	42.00	26.00
820-001-0025	21 T5/25-2	25	6F	10.00	15.00	21.00	39,79	39,00	44.00	26.00
820-001-0026	21 T5/26-2	26	6F	10.00	15.00	21.00	41,38	40,60	44.00	26.00
820-001-0027	21 T5/27-2	27	6F	10.00	15.00	21.00	42,97	42,20	48.00	30.00
820-001-0028	21 T5/28-2	28	6F	10.00	15.00	21.00	44,56	43,75	48.00	32.00
820-001-0030	21 T5/30-2	30	6F	10.00	15.00	21.00	47,75	46,95	51.00	34.00
820-001-0032	21 T5/32-2	32	6F	10.00	15.00	21.00	50,93	50,10	55.00	38.00
820-001-0036	21 T5/36-2	36	6F	10.00	15.00	21.00	57.30	56,45	63.00	38.00
820-001-0040	21 T5/40-2	40	6F	10.00	15.00	21.00	63,66	62,85	67.00	40.00
820-001-0042	21 T5/42-2	42	6F	10.00	15.00	21.00	66,85	66,00	73.00	40.00
820-001-0044	21 T5/44-0	44	6	10.00	15.00	21.00	70,03	69,20	-	45.00
820-001-0048	21 T5/48-0	48	6	10.00	15.00	21.00	76,39	75,55	-	50.00
820-001-0060	21 T5/60-0	60	6	10.00	15.00	21.00	95,49	94,65	-	65.00

5mm Teilung  
 Vorgebohrt / Zentriert  
 Material: Aluminium  
 \*Zahnriemenbreite



www.GG-ANTRIEBSTECHNIK.DE

# Zahnriemenscheiben

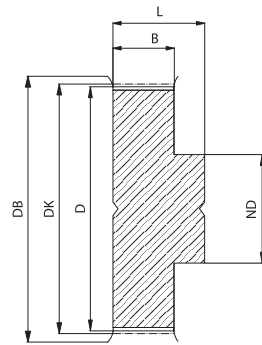

Typ 6F

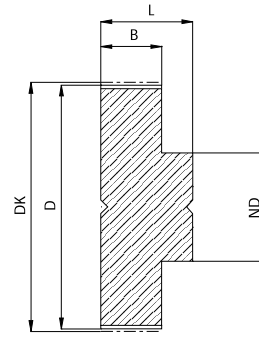

Typ 6

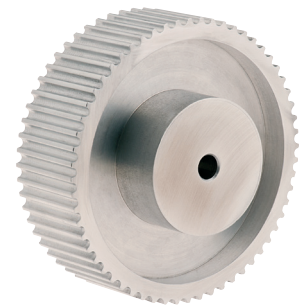

## Zahnriemenscheiben T5

G&G-Best.-Nr.	Typ	ZZ	Ausführung	ZRB*	B	L	DK	D	DB	ND
820-002-0010	27 T5/10-2	10	6F	16,00	21,00	27,00	15,91	15,05	19,50	8,00
820-002-0012	27 T5/12-2	12	6F	16,00	21,00	27,00	19,10	18,25	23,00	10,00
820-002-0014	27 T5/14-2	14	6F	16,00	21,00	27,00	22,28	21,45	25,00	13,00
820-002-0015	27 T5/15-2	15	6F	16,00	21,00	27,00	23,87	23,05	28,00	16,00
820-002-0016	27 T5/16-2	16	6F	16,00	21,00	27,00	25,47	24,60	32,00	18,00
820-002-0018	27 T5/18-2	18	6F	16,00	21,00	27,00	28,65	27,80	32,00	19,00
820-002-0019	27 T5/19-2	19	6F	16,00	21,00	27,00	30,24	29,40	36,00	22,00
820-002-0020	27 T5/20-2	20	6F	16,00	21,00	27,00	31,83	31,00	36,00	23,00
820-002-0022	27 T5/22-2	22	6F	16,00	21,00	27,00	35,01	34,25	38,00	24,00
820-002-0024	27 T5/24-2	24	6F	16,00	21,00	27,00	38,19	37,40	42,00	26,00
820-002-0025	27 T5/25-2	25	6F	16,00	21,00	27,00	39,79	39,00	44,00	26,00
820-002-0026	27 T5/26-2	26	6F	16,00	21,00	27,00	41,38	40,60	44,00	26,00
820-002-0027	27 T5/27-2	27	6F	16,00	21,00	27,00	42,97	42,20	48,00	30,00
820-002-0028	27 T5/28-2	28	6F	16,00	21,00	27,00	44,56	43,75	48,00	32,00
820-002-0030	27 T5/30-2	30	6F	16,00	21,00	27,00	47,75	46,95	51,00	34,00
820-002-0032	27 T5/32-2	32	6F	16,00	21,00	27,00	50,93	50,10	55,00	38,00
820-002-0036	27 T5/36-2	36	6F	16,00	21,00	27,00	57,30	56,45	63,00	38,00
820-002-0040	27 T5/40-2	40	6F	16,00	21,00	27,00	63,66	62,85	67,00	40,00
820-002-0042	27 T5/42-2	42	6F	16,00	21,00	27,00	66,85	66,00	73,00	40,00
820-002-0044	27 T5/44-0	44	6	16,00	21,00	27,00	70,03	69,20	-	45,00
820-002-0048	27 T5/48-0	48	6	16,00	21,00	27,00	76,39	75,55	-	50,00
820-002-0060	27 T5/60-0	60	6	16,00	21,00	27,00	95,49	94,65	-	65,00

5mm Teilung

Vorgebohrt / Zentriert

Material: Aluminium

\*Zahnriemenbreite

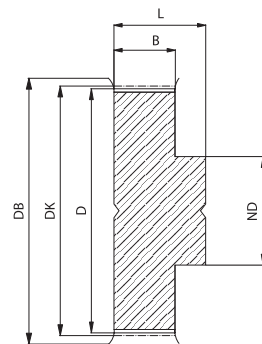

Typ 6F

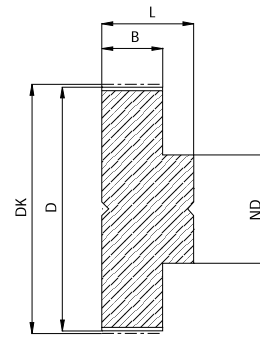

Typ 6

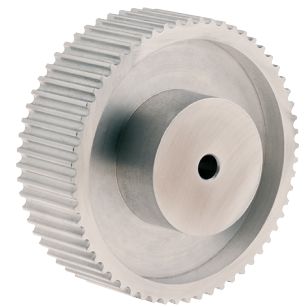

## Zahnriemenscheiben T5

G&G-Best.-Nr.	Typ	ZZ	Ausführung	ZRB*	B	L	DK	D	DB	ND
820-003-0010	36 T5/10-2	10	6F	25,00	30,00	36,00	15,91	15,05	19,50	8,00
820-003-0012	36 T5/12-2	12	6F	25,00	30,00	36,00	19,10	18,25	23,00	10,00
820-003-0014	36 T5/14-2	14	6F	25,00	30,00	36,00	22,28	21,45	25,00	13,00
820-003-0015	36 T5/15-2	15	6F	25,00	30,00	36,00	23,87	23,05	28,00	16,00
820-003-0016	36 T5/16-2	16	6F	25,00	30,00	36,00	25,47	24,60	32,00	18,00
820-003-0018	36 T5/18-2	18	6F	25,00	30,00	36,00	28,65	27,80	32,00	19,00
820-003-0019	36 T5/19-2	19	6F	25,00	30,00	36,00	30,24	29,40	36,00	22,00
820-003-0020	36 T5/20-2	20	6F	25,00	30,00	36,00	31,83	31,00	36,00	23,00
820-003-0022	36 T5/22-2	22	6F	25,00	30,00	36,00	35,01	34,25	38,00	24,00
820-003-0024	36 T5/24-2	24	6F	25,00	30,00	36,00	38,19	37,40	42,00	26,00
820-003-0025	36 T5/25-2	25	6F	25,00	30,00	36,00	39,79	39,00	44,00	26,00
820-003-0026	36 T5/26-2	26	6F	25,00	30,00	36,00	41,38	40,60	44,00	26,00
820-003-0027	36 T5/27-2	27	6F	25,00	30,00	36,00	42,97	42,20	48,00	30,00
820-003-0028	36 T5/28-2	28	6F	25,00	30,00	36,00	44,56	43,75	48,00	32,00
820-003-0030	36 T5/30-2	30	6F	25,00	30,00	36,00	47,75	46,95	51,00	34,00
820-003-0032	36 T5/32-2	32	6F	25,00	30,00	36,00	50,93	50,10	55,00	38,00
820-003-0036	36 T5/36-2	36	6F	25,00	30,00	36,00	57,30	56,45	63,00	38,00
820-003-0040	36 T5/40-2	40	6F	25,00	30,00	36,00	63,66	62,85	67,00	40,00
820-003-0042	36 T5/42-2	42	6F	25,00	30,00	36,00	66,85	66,00	73,00	40,00
820-003-0044	36 T5/44-0	44	6	25,00	30,00	36,00	70,03	69,20	-	45,00
820-003-0048	36 T5/48-0	48	6	25,00	30,00	36,00	76,39	75,55	-	50,00
820-003-0060	36 T5/60-0	60	6	25,00	30,00	36,00	95,49	94,65	-	65,00

5mm Teilung  
 Vorgebohrt / Zentriert  
 Material: Aluminium  
 \*Zahnriemenbreite

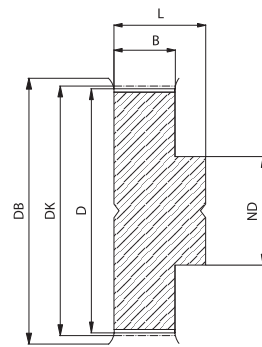

Typ 6F

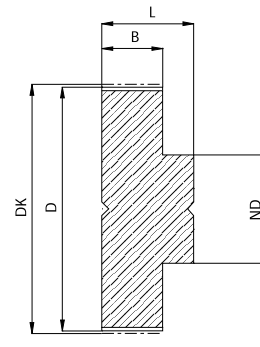

Typ 6

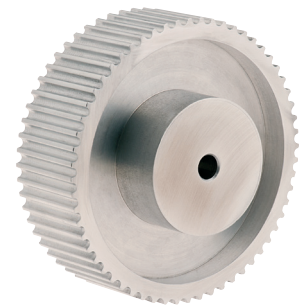

## Zahnriemenscheiben T10

G&G-Best.-Nr.	Typ	ZZ	Ausführung	ZRB*	B	L	DK	D	DB	ND
820-004-0012	31 T10/12-2	12	6F	16.00	21.00	31.00	38.19	36,35	42.00	28.00
820-004-0014	31 T10/14-2	14	6F	16.00	21.00	31.00	44.56	42,70	48.00	32.00
820-004-0015	31 T10/15-2	15	6F	16.00	21.00	31.00	47.74	45,90	51.00	32.00
820-004-0016	31 T10/16-2	16	6F	16.00	21.00	31.00	50.93	49,05	55.00	35.00
820-004-0018	31 T10/18-2	18	6F	16.00	21.00	31.00	57.29	55,45	62.00	40.00
820-004-0019	31 T10/19-2	19	6F	16.00	21.00	31.00	60.47	58,60	67.00	44.00
820-004-0020	31 T10/20-2	20	6F	16.00	21.00	31.00	63.66	61,80	67.00	46.00
820-004-0022	31 T10/22-2	22	6F	16.00	21.00	31.00	70.02	68,15	75.00	52.00
820-004-0024	31 T10/24-2	24	6F	16.00	21.00	31.00	76.39	74,55	83.00	58.00
820-004-0025	31 T10/25-2	25	6F	16.00	21.00	31.00	79.57	77,70	84.00	60.00
820-004-0026	31 T10/26-2	26	6F	16.00	21.00	31.00	82.76	80,90	88.00	60.00
820-004-0027	31 T10/27-2	27	6F	16.00	21.00	31.00	85.94	84,10	91.00	60.00
820-004-0028	31 T10/28-2	28	6F	16.00	21.00	31.00	89.12	87,25	94.00	60.00
820-004-0030	31 T10/30-2	30	6F	16.00	21.00	31.00	95.49	93,65	98.00	60.00
820-004-0032	31 T10/32-2	32	6F	16.00	21.00	31.00	101.85	100,00	108.00	65.00
820-004-0036	31 T10/36-2	36	6F	16.00	21.00	31.00	114.59	112,75	119.00	70.00
820-004-0040	31 T10/40-2	40	6F	16.00	21.00	31.00	127.32	125,45	131.00	80.00
820-004-0044	31 T10/44-0	44	6	16.00	21.00	31.00	140.05	138,20	-	88.00
820-004-0048	31 T10/48-0	48	6	16.00	21.00	31.00	152.78	150,95	-	95.00
820-004-0060	31 T10/60-0	60	6	16.00	21.00	31.00	190.98	189,10	-	110.00

10mm Teilung  
 Vorgebohrt / Zentriert  
 Material: Aluminium  
 \*Zahnriemenbreite

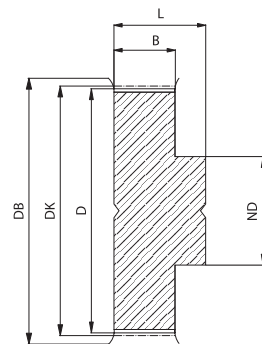

Typ 6F

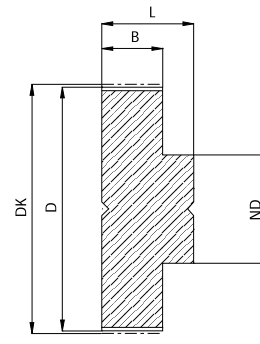

Typ 6

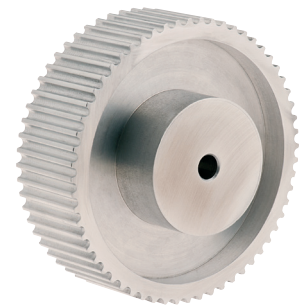

## Zahnriemenscheiben T10

G&G-Best.-Nr.	Typ	ZZ	Ausführung	ZRB*	B	L	DK	D	DB	ND
820-005-0012	40 T10/12-2	12	6F	25.00	30.00	40.00	38.19	36,35	42.00	28.00
820-005-0014	40 T10/14-2	14	6F	25.00	30.00	40.00	44.56	42,70	48.00	32.00
820-005-0015	40 T10/15-2	15	6F	25.00	30.00	40.00	47.74	45,90	51.00	32.00
820-005-0016	40 T10/16-2	16	6F	25.00	30.00	40.00	50.93	49,05	55.00	35.00
820-005-0018	40 T10/18-2	18	6F	25.00	30.00	40.00	57.29	55,45	62.00	40.00
820-005-0019	40 T10/19-2	19	6F	25.00	30.00	40.00	60.47	58,60	67.00	44.00
820-005-0020	40 T10/20-2	20	6F	25.00	30.00	40.00	63.66	61,80	67.00	46.00
820-005-0022	40 T10/22-2	22	6F	25.00	30.00	40.00	70.02	68,15	75.00	52.00
820-005-0024	40 T10/24-2	24	6F	25.00	30.00	40.00	76.39	74,55	83.00	58.00
820-005-0025	40 T10/25-2	25	6F	25.00	30.00	40.00	79.57	77,70	84.00	60.00
820-005-0026	40 T10/26-2	26	6F	25.00	30.00	40.00	82.76	80,90	88.00	60.00
820-005-0027	40 T10/27-2	27	6F	25.00	30.00	40.00	85.94	84,10	91.00	60.00
820-005-0028	40 T10/28-2	28	6F	25.00	30.00	40.00	89.12	87,25	94.00	60.00
820-005-0030	40 T10/30-2	30	6F	25.00	30.00	40.00	95.49	93,65	98.00	60.00
820-005-0032	40 T10/32-2	32	6F	25.00	30.00	40.00	101.85	100,00	108.00	65.00
820-005-0036	40 T10/36-2	36	6F	25.00	30.00	40.00	114.59	112,75	119.00	70.00
820-005-0040	40 T10/40-2	40	6F	25.00	30.00	40.00	127.32	125,45	131.00	80.00
820-005-0044	40 T10/44-0	44	6	25.00	30.00	40.00	140.05	138,20	-	88.00
820-005-0048	40 T10/48-0	48	6	25.00	30.00	40.00	152.78	150,95	-	95.00
820-005-0060	40 T10/60-0	60	6	25.00	37.00	40.00	190.98	189,10	-	110.00

10mm Teilung  
 Vorgebohrt / Zentriert  
 Material: Aluminium  
 \*Zahnriemenbreite

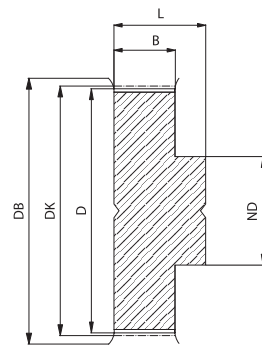

Typ 6F

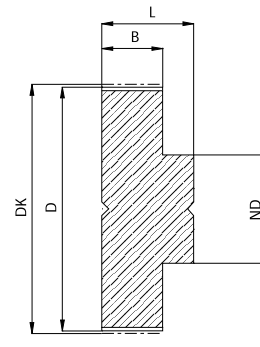

Typ 6

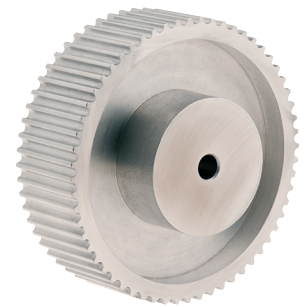

## Zahnriemenscheiben T10

G&G-Best.-Nr.	Typ	ZZ	Ausführung	ZRB*	B	L	DK	D	DB	ND
820-006-0018	47 T10/18-2	18	6F	32.00	37.00	47.00	57.29	55,45	62.00	40.00
820-006-0019	47 T10/19-2	19	6F	32.00	37.00	47.00	60.47	58,60	67.00	44.00
820-006-0020	47 T10/20-2	20	6F	32.00	37.00	47.00	63.66	61,80	67.00	46.00
820-006-0022	47 T10/22-2	22	6F	32.00	37.00	47.00	70.02	68,15	75.00	52.00
820-006-0024	47 T10/24-2	24	6F	32.00	37.00	47.00	76.39	74,55	83.00	58.00
820-006-0025	47 T10/25-2	25	6F	32.00	37.00	47.00	79.57	77,70	84.00	60.00
820-006-0026	47 T10/26-2	26	6F	32.00	37.00	47.00	82.76	80,90	88.00	60.00
820-006-0027	47 T10/27-2	27	6F	32.00	37.00	47.00	85.94	84,10	91.00	60.00
820-006-0028	47 T10/28-2	28	6F	32.00	37.00	47.00	89.12	87,25	94.00	60.00
820-006-0030	47 T10/30-2	30	6F	32.00	37.00	47.00	95.49	93,65	98.00	60.00
820-006-0032	47 T10/32-2	32	6F	32.00	37.00	47.00	101.85	100,00	108.00	65.00
820-006-0036	47 T10/36-2	36	6F	32.00	37.00	47.00	114.59	112,75	119.00	70.00
820-006-0040	47 T10/40-2	40	6F	32.00	37.00	47.00	127.32	125,45	131.00	80.00
820-006-0044	47 T10/44-0	44	6	32.00	37.00	47.00	140.05	138,20	-	88.00
820-006-0048	47 T10/48-0	48	6	32.00	37.00	47.00	152.78	150,95	-	95.00
820-006-0060	47 T10/60-0	60	6	32.00	37.00	47.00	190.98	189,10	-	110.00

10mm Teilung  
 Vorgebohrt / Zentriert  
 Material: Aluminium  
 \*Zahnriemenbreite

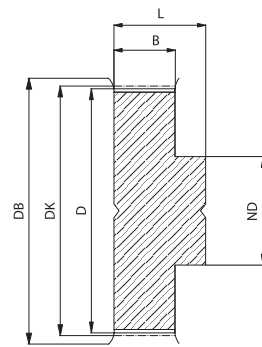

Typ 6F

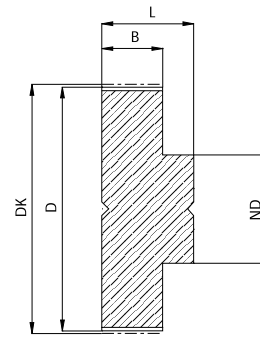

Typ 6

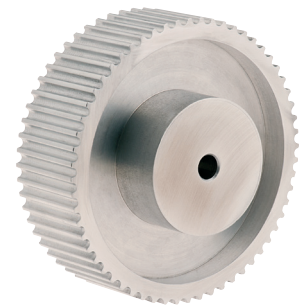

## Zahnriemenscheiben T10

G&G-Best.-Nr.	Typ	ZZ	Ausführung	ZRB*	B	L	DK	D	DB	ND
820-007-0018	66 T10/18-2	18	6F	50.00	56.00	66.00	57.29	55,45	62.00	40.00
820-007-0019	66 T10/19-2	19	6F	50.00	56.00	66.00	60.47	58,60	67.00	44.00
820-007-0020	66 T10/20-2	20	6F	50.00	56.00	66.00	63.66	61,80	67.00	46.00
820-007-0022	66 T10/22-2	22	6F	50.00	56.00	66.00	70.02	68,15	75.00	52.00
820-007-0024	66 T10/24-2	24	6F	50.00	56.00	66.00	76.39	74,55	83.00	58.00
820-007-0025	66 T10/25-2	25	6F	50.00	56.00	66.00	79.57	77,70	84.00	60.00
820-007-0026	66 T10/26-2	26	6F	50.00	56.00	66.00	82.76	80,90	88.00	60.00
820-007-0027	66 T10/27-2	27	6F	50.00	56.00	66.00	85.94	84,10	91.00	60.00
820-007-0028	66 T10/28-2	28	6F	50.00	56.00	66.00	89.12	87,25	94.00	60.00
820-007-0030	66 T10/30-2	30	6F	50.00	56.00	66.00	95.49	93,65	98.00	60.00
820-007-0032	66 T10/32-2	32	6F	50.00	56.00	66.00	101.85	100,00	108.00	65.00
820-007-0036	66 T10/36-2	36	6F	50.00	56.00	66.00	114.59	112,75	119.00	70.00
820-007-0040	66 T10/40-2	40	6F	50.00	56.00	66.00	127.32	125,45	131.00	80.00
820-007-0044	66 T10/44-0	44	6	50.00	56.00	66.00	140.05	138,20	-	88.00
820-007-0048	66 T10/48-0	48	6	50.00	56.00	66.00	152.78	150,95	-	95.00
820-007-0060	66 T10/60-0	60	6	50.00	56.00	66.00	190.98	189,10	-	110.00

10mm Teilung  
 Vorgebohrt / Zentriert  
 Material: Aluminium  
 \*Zahnriemenbreite



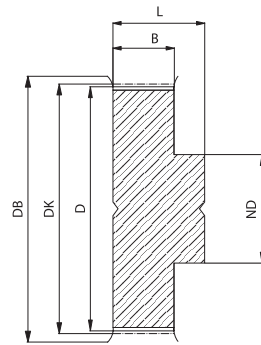

Typ 6F

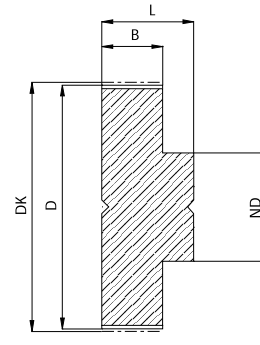

Typ 6

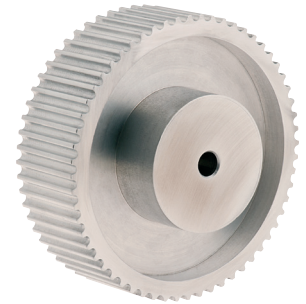

## Zahnriemenscheiben AT5

G&G-Best.-Nr.	Typ	ZZ	Ausführung	ZRB*	B	L	DK	D	DB	ND
830-001-0012	21 AT5/12-2	12	6F	10.00	15.00	21.00	19.10	17,85	23.00	11.00
830-001-0014	21 AT5/14-2	14	6F	10.00	15.00	21.00	22,28	21,05	24.00	14.00
830-001-0015	21 AT5/15-2	15	6F	10.00	15.00	21.00	23,87	22,65	27.00	16.00
830-001-0016	21 AT5/16-2	16	6F	10.00	15.00	21.00	25,47	24,20	30.00	18.00
830-001-0018	21 AT5/18-2	18	6F	10.00	15.00	21.00	28,65	27,40	30.00	20.00
830-001-0019	21 AT5/19-2	19	6F	10.00	15.00	21.00	30,24	29,00	33.00	22.00
830-001-0020	21 AT5/20-2	20	6F	10.00	15.00	21.00	31,83	30,60	33.00	23.00
830-001-0022	21 AT5/22-2	22	6F	10.00	15.00	21.00	35,01	34,85	36.00	24.00
830-001-0024	21 AT5/24-2	24	6F	10.00	15.00	21.00	38,19	37,00	40.00	26.00
830-001-0025	21 AT5/25-2	25	6F	10.00	15.00	21.00	39,79	38,60	46.00	26.00
830-001-0026	21 AT5/26-2	26	6F	10.00	15.00	21.00	41,38	40,20	46.00	26.00
830-001-0027	21 AT5/27-2	27	6F	10.00	15.00	21.00	42,97	41,80	46.00	30.00
830-001-0028	21 AT5/28-2	28	6F	10.00	15.00	21.00	44,56	43,35	50.00	32.00
830-001-0030	21 AT5/30-2	30	6F	10.00	15.00	21.00	47,75	46,55	50.00	34.00
830-001-0032	21 AT5/32-2	32	6F	10.00	15.00	21.00	50,93	49,70	55.00	38.00
830-001-0036	21 AT5/36-2	36	6F	10.00	15.00	21.00	57,30	56,05	62.00	38.00
830-001-0040	21 AT5/40-2	40	6F	10.00	15.00	21.00	63,66	62,45	67.00	40.00
830-001-0042	21 AT5/42-2	42	6F	10.00	15.00	21.00	66,85	65,60	73.00	40.00
830-001-0044	21 AT5/44-0	44	6	10.00	15.00	21.00	70,03	68,80	-	45.00
830-001-0048	21 AT5/48-0	48	6	10.00	15.00	21.00	76,39	75,15	-	50.00
830-001-0060	21 AT5/60-0	60	6	10.00	15.00	21.00	95,49	94,25	-	65.00

5mm Teilung  
 Vorgebohrt / Zentriert  
 Material: Aluminium  
 \*Zahnriemenbreite

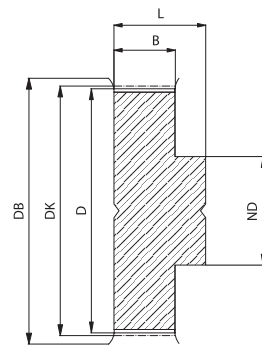

Typ 6F

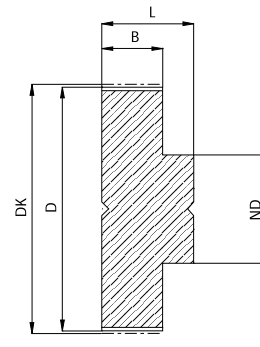

Typ 6

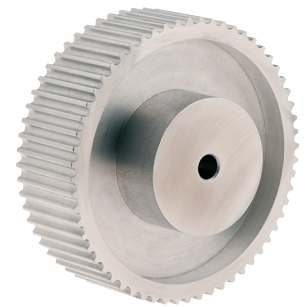

## Zahnriemenscheiben AT5

G&G-Best.-Nr.	Typ	ZZ	Ausführung	ZRB*	B	L	DK	D	DB	ND
830-002-0012	27 AT5/12-2	12	6F	16.00	21.00	27.00	19.10	17,85	23.00	11.00
830-002-0014	27 AT5/14-2	14	6F	16.00	21.00	27.00	22,28	21,05	24.00	14.00
830-002-0015	27 AT5/15-2	15	6F	16.00	21.00	27.00	23,87	22,65	27.00	16.00
830-002-0016	27 AT5/16-2	16	6F	16.00	21.00	27.00	25,47	24,20	30.00	18.00
830-002-0018	27 AT5/18-2	18	6F	16.00	21.00	27.00	28,65	27,40	30.00	20.00
830-002-0019	27 AT5/19-2	19	6F	16.00	21.00	27.00	30,24	29,00	33.00	22.00
830-002-0020	27 AT5/20-2	20	6F	16.00	21.00	27.00	31,83	30,60	33.00	23.00
830-002-0022	27 AT5/22-2	22	6F	16.00	21.00	27.00	35,01	34,85	36.00	24.00
830-002-0024	27 AT5/24-2	24	6F	16.00	21.00	27.00	38,19	37,00	40.00	26.00
830-002-0025	27 AT5/25-2	25	6F	16.00	21.00	27.00	39,79	38,60	46.00	26.00
830-002-0026	27 AT5/26-2	26	6F	16.00	21.00	27.00	41,38	40,20	46.00	26.00
830-002-0027	27 AT5/27-2	27	6F	16.00	21.00	27.00	42,97	41,80	46.00	30.00
830-002-0028	27 AT5/28-2	28	6F	16.00	21.00	27.00	44,56	43,35	50.00	32.00
830-002-0030	27 AT5/30-2	30	6F	16.00	21.00	27.00	47,75	46,55	50.00	34.00
830-002-0032	27 AT5/32-2	32	6F	16.00	21.00	27.00	50,93	49,70	55.00	38.00
830-002-0036	27 AT5/36-2	36	6F	16.00	21.00	27.00	57,30	56,05	62.00	38.00
830-002-0040	27 AT5/40-2	40	6F	16.00	21.00	27.00	63,66	62,45	67.00	40.00
830-002-0042	27 AT5/42-2	42	6F	16.00	21.00	27.00	66,85	65,60	73.00	40.00
830-002-0044	27 AT5/44-0	44	6	16.00	21.00	27.00	70,03	68,80	-	45.00
830-002-0048	27 AT5/48-0	48	6	16.00	21.00	27.00	76,39	75,15	-	50.00
830-002-0060	27 AT5/60-0	60	6	16.00	21.00	27.00	95,49	94,25	-	65.00

5mm Teilung  
 Vorgebohrt / Zentriert  
 Material: Aluminium  
 \*Zahnriemenbreite

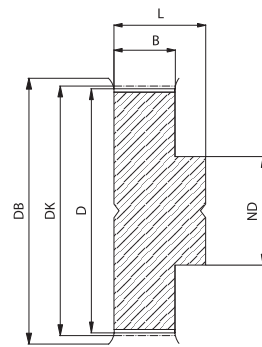

Typ 6F

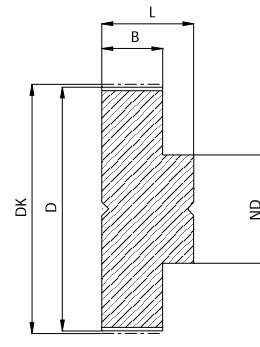

Typ 6

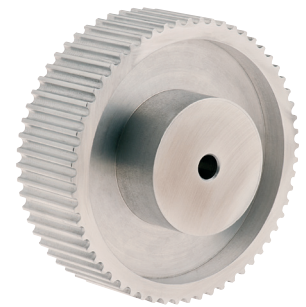

## Zahnriemenscheiben AT5

G&G-Best.-Nr.	Typ	ZZ	Ausführung	ZRB*	B	L	DK	D	DB	ND
830-003-0012	36 AT5/12-2	12	6F	25.00	30.00	36.00	19.10	17,85	23.00	11.00
830-003-0014	36 AT5/14-2	14	6F	25.00	30.00	36.00	22,28	21,05	24.00	14.00
830-003-0015	36 AT5/15-2	15	6F	25.00	30.00	36.00	23,87	22,65	27.00	16.00
830-003-0016	36 AT5/16-2	16	6F	25.00	30.00	36.00	25,47	24,20	30.00	18.00
830-003-0018	36 AT5/18-2	18	6F	25.00	30.00	36.00	28,65	27,40	30.00	20.00
830-003-0019	36 AT5/19-2	19	6F	25.00	30.00	36.00	30,24	29,00	33.00	22.00
830-003-0020	36 AT5/20-2	20	6F	25.00	30.00	36.00	31,83	30,60	33.00	23.00
830-003-0022	36 AT5/22-2	22	6F	25.00	30.00	36.00	35,01	34,85	36.00	24.00
830-003-0024	36 AT5/24-2	24	6F	25.00	30.00	36.00	38,19	37,00	40.00	26.00
830-003-0025	36 AT5/25-2	25	6F	25.00	30.00	36.00	39,79	38,60	46.00	26.00
830-003-0026	36 AT5/26-2	26	6F	25.00	30.00	36.00	41,38	40,20	46.00	26.00
830-003-0027	36 AT5/27-2	27	6F	25.00	30.00	36.00	42,97	41,80	46.00	30.00
830-003-0028	36 AT5/28-2	28	6F	25.00	30.00	36.00	44,56	43,35	50.00	32.00
830-003-0030	36 AT5/30-2	30	6F	25.00	30.00	36.00	47,75	46,55	50.00	34.00
830-003-0032	36 AT5/32-2	32	6F	25.00	30.00	36.00	50,93	49,70	55.00	38.00
830-003-0036	36 AT5/36-2	36	6F	25.00	30.00	36.00	57,30	56,05	62.00	38.00
830-003-0040	36 AT5/40-2	40	6F	25.00	30.00	36.00	63,66	62,45	67.00	40.00
830-003-0042	36 AT5/42-2	42	6F	25.00	30.00	36.00	66,85	65,60	73.00	40.00
830-003-0044	36 AT5/44-0	44	6	25.00	30.00	36.00	70,03	68,80	-	45.00
830-003-0048	36 AT5/48-0	48	6	25.00	30.00	36.00	76,39	75,15	-	50.00
830-003-0060	36 AT5/60-0	60	6	25.00	30.00	36.00	95,49	94,25	-	65.00

5mm Teilung  
 Vorgebohrt / Zentriert  
 Material: Aluminium  
 \*Zahnriemenbreite

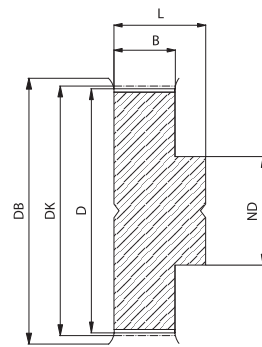

Typ 6F

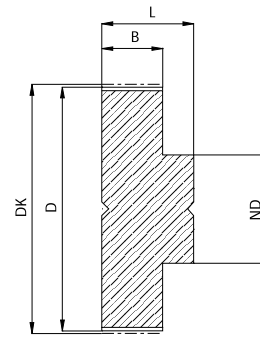

Typ 6

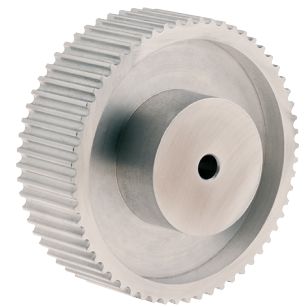

## Zahnriemenscheiben AT10

G&G-Best.-Nr.	Typ	ZZ	Ausführung	ZRB*	B	L	DK	D	DB	ND
830-004-0015	31 AT10/15-2	15	6F	16.00	21.00	31.00	47.74	45,90	50.00	32.00
830-004-0016	31 AT10/16-2	16	6F	16.00	21.00	31.00	50.93	49,05	55.00	35.00
830-004-0018	31 AT10/18-2	18	6F	16.00	21.00	31.00	57.29	55,45	62.00	40.00
830-004-0019	31 AT10/19-2	19	6F	16.00	21.00	31.00	60.47	58,60	67.00	44.00
830-004-0020	31 AT10/20-2	20	6F	16.00	21.00	31.00	63.66	61,80	67.00	46.00
830-004-0022	31 AT10/22-2	22	6F	16.00	21.00	31.00	70.02	68,15	73.00	52.00
830-004-0024	31 AT10/24-2	24	6F	16.00	21.00	31.00	76.39	74,55	80.00	58.00
830-004-0025	31 AT10/25-2	25	6F	16.00	21.00	31.00	79.57	77,70	84.00	60.00
830-004-0026	31 AT10/26-2	26	6F	16.00	21.00	31.00	82.76	80,90	88.00	60.00
830-004-0027	31 AT10/27-2	27	6F	16.00	21.00	31.00	85.94	84,10	88.00	60.00
830-004-0028	31 AT10/28-2	28	6F	16.00	21.00	31.00	89.12	87,25	94.00	60.00
830-004-0030	31 AT10/30-2	30	6F	16.00	21.00	31.00	95.49	93,65	98.00	60.00
830-004-0032	31 AT10/32-2	32	6F	16.00	21.00	31.00	101.85	100,00	108.00	65.00
830-004-0036	31 AT10/36-2	36	6F	16.00	21.00	31.00	114.59	112,75	118.00	70.00
830-004-0040	31 AT10/40-2	40	6F	16.00	21.00	31.00	127.32	125,45	129.00	80.00
830-004-0044	31 AT10/44-0	44	6	16.00	21.00	31.00	140.05	138,20	-	88.00
830-004-0048	31 AT10/48-0	48	6	16.00	21.00	31.00	152.78	150,95	-	95.00
830-004-0060	31 AT10/60-0	60	6	16.00	21.00	31.00	190.98	189,10	-	110.00

10mm Teilung  
 Vorgebohrt / Zentriert  
 Material: Aluminium  
 \*Zahnriemenbreite

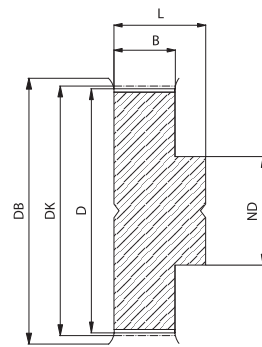

Typ 6F

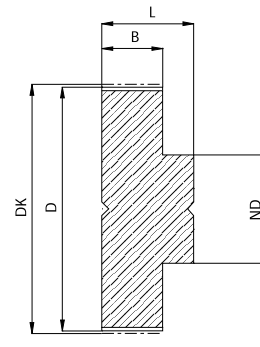

Typ 6

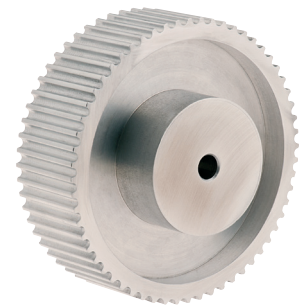

## Zahnriemenscheiben AT10

G&G-Best.-Nr.	Typ	ZZ	Ausführung	ZRB*	B	L	DK	D	DB	ND
830-005-0015	40 AT10/15-2	15	6F	25.00	30.00	40.00	47.74	45,90	50.00	32.00
830-005-0016	40 AT10/16-2	16	6F	25.00	30.00	40.00	50.93	49,05	55.00	35.00
830-005-0018	40 AT10/18-2	18	6F	25.00	30.00	40.00	57.29	55,45	62.00	40.00
830-005-0019	40 AT10/19-2	19	6F	25.00	30.00	40.00	60.47	58,60	67.00	44.00
830-005-0020	40 AT10/20-2	20	6F	25.00	30.00	40.00	63.66	61.80	67.00	46.00
830-005-0022	40 AT10/22-2	22	6F	25.00	30.00	40.00	70.02	68,15	73.00	52.00
830-005-0024	40 AT10/24-2	24	6F	25.00	30.00	40.00	76.39	74,55	80.00	58.00
830-005-0025	40 AT10/25-2	25	6F	25.00	30.00	40.00	79.57	77,70	84.00	60.00
830-005-0026	40 AT10/26-2	26	6F	25.00	30.00	40.00	82.76	80,90	88.00	60.00
830-005-0027	40 AT10/27-2	27	6F	25.00	30.00	40.00	85.94	84,10	88.00	60.00
830-005-0028	40 AT10/28-2	28	6F	25.00	30.00	40.00	89.12	87,25	94.00	60.00
830-005-0030	40 AT10/30-2	30	6F	25.00	30.00	40.00	95.49	93,65	98.00	60.00
830-005-0032	40 AT10/32-2	32	6F	25.00	30.00	40.00	101.85	100,00	108.00	65.00
830-005-0036	40 AT10/36-2	36	6F	25.00	30.00	40.00	114.59	112,75	118.00	70.00
830-005-0040	40 AT10/40-2	40	6F	25.00	30.00	40.00	127.32	125,45	129.00	80.00
830-005-0044	40 AT10/44-0	44	6	25.00	30.00	40.00	140.05	138,20	-	88.00
830-005-0048	40 AT10/48-0	48	6	25.00	30.00	40.00	152.78	150,95	-	95.00
830-005-0060	40 AT10/60-0	60	6	25.00	37.00	40.00	190.98	189,10	-	110.00

10mm Teilung  
 Vorgebohrt / Zentriert  
 Material: Aluminium  
 \*Zahnriemenbreite

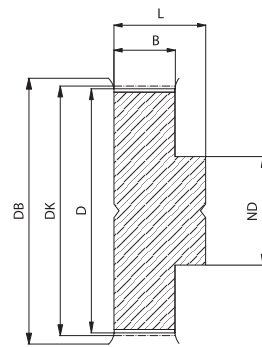

Typ 6F

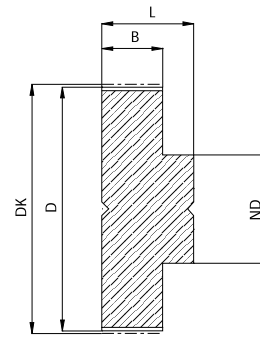

Typ 6

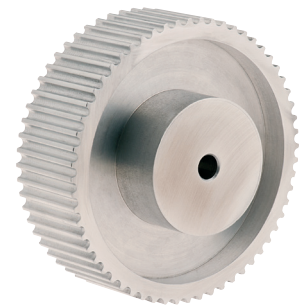

## Zahnriemenscheiben AT10

G&G-Best.-Nr.	Typ	ZZ	Ausführung	ZRB*	B	L	DK	D	DB	ND
830-006-0018	47 AT10/18-2	18	6F	32.00	37.00	47.00	57.29	55,45	62.00	40.00
830-006-0019	47 AT10/19-2	19	6F	32.00	37.00	47.00	60.47	58,60	67.00	44.00
830-006-0020	47 AT10/20-2	20	6F	32.00	37.00	47.00	63.66	61,80	67.00	46.00
830-006-0022	47 AT10/22-2	22	6F	32.00	37.00	47.00	70.02	68,15	73.00	52.00
830-006-0024	47 AT10/24-2	24	6F	32.00	37.00	47.00	76.39	74,55	80.00	58.00
830-006-0025	47 AT10/25-2	25	6F	32.00	37.00	47.00	79.57	77,70	84.00	60.00
830-006-0026	47 AT10/26-2	26	6F	32.00	37.00	47.00	82.76	80,90	88.00	60.00
830-006-0027	47 AT10/27-2	27	6F	32.00	37.00	47.00	85.94	84,10	88.00	60.00
830-006-0028	47 AT10/28-2	28	6F	32.00	37.00	47.00	89.12	87,25	94.00	60.00
830-006-0030	47 AT10/30-2	30	6F	32.00	37.00	47.00	95.49	93,65	98.00	60.00
830-006-0032	47 AT10/32-2	32	6F	32.00	37.00	47.00	101.85	100,00	108.00	65.00
830-006-0036	47 AT10/36-2	36	6F	32.00	37.00	47.00	114.59	112,75	118.00	70.00
830-006-0040	47 AT10/40-2	40	6F	32.00	37.00	47.00	127.32	125,45	129.00	80.00
830-006-0044	47 AT10/44-0	44	6	32.00	37.00	47.00	140.05	138,20	-	88.00
830-006-0048	47 AT10/48-0	48	6	32.00	37.00	47.00	152.78	150,95	-	95.00
830-006-0060	47 AT10/60-0	60	6	32.00	37.00	47.00	190.98	189,10	-	110.00

10mm Teilung  
 Vorgebohrt / Zentriert  
 Material: Aluminium  
 \*Zahnriemenbreite

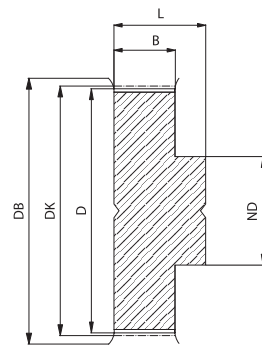

Typ 6F

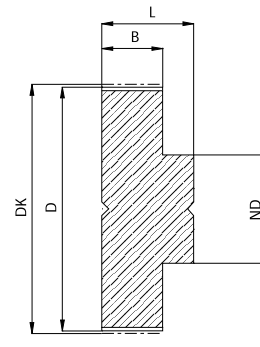

Typ 6

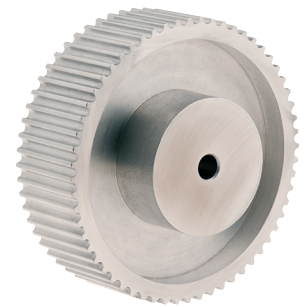

## Zahnriemenscheiben AT10

G&G-Best.-Nr.	Typ	ZZ	Ausführung	ZRB*	B	L	DK	D	DB	ND
830-007-0018	66 AT10/18-2	18	6F	50.00	56.00	66.00	57.29	55,45	62.00	40.00
830-007-0019	66 AT10/19-2	19	6F	50.00	56.00	66.00	60.47	58,60	67.00	44.00
830-007-0020	66 AT10/20-2	20	6F	50.00	56.00	66.00	63.66	61,80	67.00	46.00
830-007-0022	66 AT10/22-2	22	6F	50.00	56.00	66.00	70.02	68,15	73.00	52.00
830-007-0024	66 AT10/24-2	24	6F	50.00	56.00	66.00	76.39	74,55	80.00	58.00
830-007-0025	66 AT10/25-2	25	6F	50.00	56.00	66.00	79.57	77,70	84.00	60.00
830-007-0026	66 AT10/26-2	26	6F	50.00	56.00	66.00	82.76	80,90	88.00	60.00
830-007-0027	66 AT10/27-2	27	6F	50.00	56.00	66.00	85.94	84,10	88.00	60.00
830-007-0028	66 AT10/28-2	28	6F	50.00	56.00	66.00	89.12	87,25	94.00	60.00
830-007-0030	66 AT10/30-2	30	6F	50.00	56.00	66.00	95.49	93,65	98.00	60.00
830-007-0032	66 AT10/32-2	32	6F	50.00	56.00	66.00	101.85	100,00	108.00	65.00
830-007-0036	66 AT10/36-2	36	6F	50.00	56.00	66.00	114.59	112,75	118.00	70.00
830-007-0040	66 AT10/40-2	40	6F	50.00	56.00	66.00	127.32	125,45	129.00	80.00
830-007-0044	66 AT10/44-0	44	6	50.00	56.00	66.00	140.05	138,20	-	88.00
830-007-0048	66 AT10/48-0	48	6	50.00	56.00	66.00	152.78	150,95	-	95.00
830-007-0060	66 AT10/60-0	60	6	50.00	56.00	66.00	190.98	189,10	-	110.00

10mm Teilung  
 Vorgebohrt / Zentriert  
 Material: Aluminium  
 \*Zahnriemenbreite

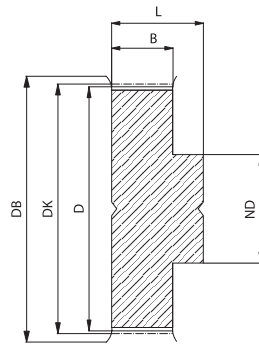

Typ 6F

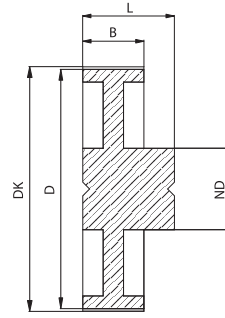

Typ 6W



## Zahnriemenscheiben HTD 5M

G&G-Best.-Nr.	Typ	ZZ	Ausführung	ZRB*	B	L	DK	D	DB	ND
800-004-0012	HTD 12-5M-09	12	6F	9.00	14,50	20.00	19,10	17,96	23.00	13.00
800-004-0014	HTD 14-5M-09	14	6F	9.00	14,50	20.00	22,28	21,14	24.00	14.00
800-004-0015	HTD 15-5M-09	15	6F	9.00	14,50	20.00	23,87	22,73	27.00	16.00
800-004-0016	HTD 16-5M-09	16	6F	9.00	14,50	20.00	25,46	24,32	27.00	16.50
800-004-0018	HTD 18-5M-09	18	6F	9.00	14,50	20.00	28,65	27,51	30.00	20.00
800-004-0020	HTD 20-5M-09	20	6F	9.00	14,50	22.50	31,83	30,69	33.00	23.00
800-004-0021	HTD 21-5M-09	21	6F	9.00	14,50	22.50	33,42	32,28	36.00	24.00
800-004-0022	HTD 22-5M-09	22	6F	9.00	14,50	22.50	35,01	33,87	36.00	25.00
800-004-0024	HTD 24-5M-09	24	6F	9.00	14,50	22.50	38,2	37,06	40.00	27.00
800-004-0026	HTD 26-5M-09	26	6F	9.00	14,50	22.50	41,38	40,24	46.00	30.00
800-004-0028	HTD 28-5M-09	28	6F	9.00	14,50	22.50	44,56	43,42	50.00	30.50
800-004-0030	HTD 30-5M-09	30	6F	9.00	14,50	22.50	47,75	46,60	50.00	35.00
800-004-0032	HTD 32-5M-09	32	6F	9.00	14,50	22.50	50,93	49,79	55.00	38.00
800-004-0036	HTD 36-5M-09	36	6F	9.00	14,50	22.50	57,3	56,16	62.00	38.00
800-004-0040	HTD 40-5M-09	40	6F	9.00	14,50	22.50	63,66	62,52	67.00	38.00
800-004-0044	HTD 44-5M-09	44	6W	9.00	14,50	25.50	70,03	68,89	-	38.00
800-004-0048	HTD 48-5M-09	48	6W	9.00	14,50	25.50	76,39	75,25	-	45.00
800-004-0060	HTD 60-5M-09	60	6W	9.00	14,50	25.50	95,49	94,35	-	45.00
800-004-0072	HTD 72-5M-09	72	6W	9.00	14,50	25.50	114,59	113,45	-	45.00

5mm Teilung

Vorgebohrt / Zentriert

Material:

bis Zähnezahl (ZZ) 40 in Stahl

ab Zähnezahl (ZZ) 44 in Aluminium

\*Zahnriemenbreite



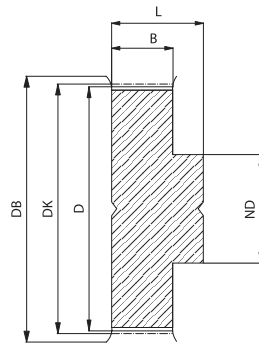

Typ 6F

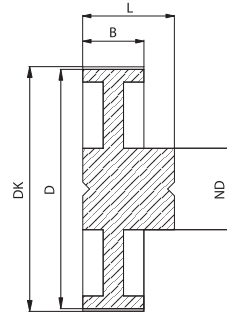

Typ 6W

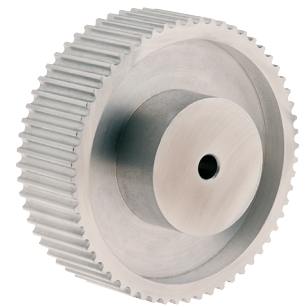

## Zahnriemenscheiben HTD 5M

G&G-Best.-Nr.	Typ	ZZ	Ausführung	ZRB*	B	L	DK	D	DB	ND
800-005-0012	HTD 12-5M-15	12	6F	15.00	20,50	26.00	19,10	17,96	23.00	13.00
800-005-0014	HTD 14-5M-15	14	6F	15.00	20,50	26.00	22,28	21,14	24.00	14.00
800-005-0015	HTD 15-5M-15	15	6F	15.00	20,50	26.00	23,87	22,73	27.00	16.00
800-005-0016	HTD 16-5M-15	16	6F	15.00	20,50	26.00	25,46	24,32	27.00	16.50
800-005-0018	HTD 18-5M-15	18	6F	15.00	20,50	26.00	28,65	27,51	30.00	20.00
800-005-0020	HTD 20-5M-15	20	6F	15.00	20,50	26.00	31,83	30,69	33.00	23.00
800-005-0021	HTD 21-5M-15	21	6F	15.00	20,50	26.00	33,42	32,28	36.00	24.00
800-005-0022	HTD 22-5M-15	22	6F	15.00	20,50	26.00	35,01	33,87	36.00	25.00
800-005-0024	HTD 24-5M-15	24	6F	15.00	20,50	28.00	38,2	37,06	40.00	27.00
800-005-0026	HTD 26-5M-15	26	6F	15.00	20,50	28.00	41,38	40,24	46.00	30.00
800-005-0028	HTD 28-5M-15	28	6F	15.00	20,50	28.00	44,56	43,42	50.00	30.50
800-005-0030	HTD 30-5M-15	30	6F	15.00	20,50	28.00	47,75	46,6	50.00	35.00
800-005-0032	HTD 32-5M-15	32	6F	15.00	20,50	28.00	50,93	49,79	55.00	38.00
800-005-0036	HTD 36-5M-15	36	6F	15.00	20,50	28.00	57,3	56,16	62.00	38.00
800-005-0040	HTD 40-5M-15	40	6F	15.00	20,50	28.00	63,66	62,52	67.00	38.00
800-005-0044	HTD 44-5M-15	44	6W	15.00	20,50	30.00	70,03	68,89	-	38.00
800-005-0048	HTD 48-5M-15	48	6W	15.00	20,50	30.00	76,39	75,25	-	45.00
800-005-0060	HTD 60-5M-15	60	6W	15.00	20,50	30.00	95,49	94,35	-	45.00
800-005-0072	HTD 72-5M-15	72	6W	15.00	20,50	30.00	114,59	113,45	-	45.00

5mm Teilung

Vorgebohrt / Zentriert

Material:

bis Zähnezahl (ZZ) 40 in Stahl

ab Zähnezahl (ZZ) 44 in Aluminium

\*Zahnriemenbreite

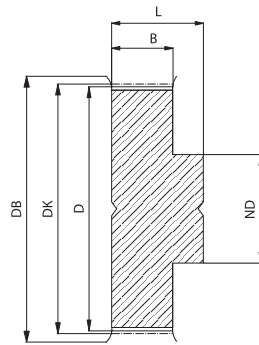

Typ 6F

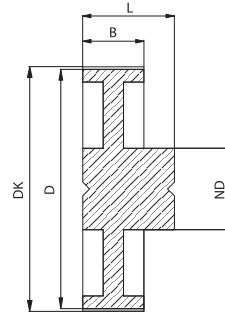

Typ 6W

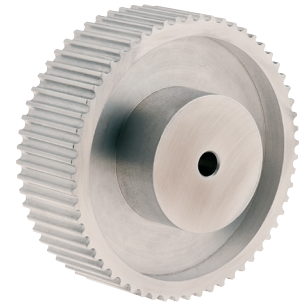

## Zahnriemenscheiben HTD 5M

G&G-Best.-Nr.	Typ	ZZ	Ausführung	ZRB*	B	L	DK	D	DB	ND
800-006-0012	HTD 12-5M-25	12	6F	25.00	30,50	36,00	19,10	17,96	23.00	13.00
800-006-0014	HTD 14-5M-25	14	6F	25.00	30,50	36,00	22,28	21,14	24.00	14.00
800-006-0015	HTD 15-5M-25	15	6F	25.00	30,50	36,00	23,87	22,73	27.00	16.00
800-006-0016	HTD 16-5M-25	16	6F	25.00	30,50	36,00	25,46	24,32	27.00	16.50
800-006-0018	HTD 18-5M-25	18	6F	25.00	30,50	36,00	28,65	27,51	30.00	20.00
800-006-0020	HTD 20-5M-25	20	6F	25.00	30,50	36,00	31,83	30,69	33.00	23.00
800-006-0021	HTD 21-5M-25	21	6F	25.00	30,50	38.00	33,42	32,28	36.00	24.00
800-006-0022	HTD 22-5M-25	22	6F	25.00	30,50	38.00	35,01	33,87	36.00	25.00
800-006-0024	HTD 24-5M-25	24	6F	25.00	30,50	38.00	38,2	37,06	40.00	27.00
800-006-0026	HTD 26-5M-25	26	6F	25.00	30,50	38.00	41,38	40,24	46.00	30.00
800-006-0028	HTD 28-5M-25	28	6F	25.00	30,50	38.00	44,56	43,42	50.00	30.50
800-006-0030	HTD 30-5M-25	30	6F	25.00	30,50	38.00	47,75	46,6	50.00	35.00
800-006-0032	HTD 32-5M-25	32	6F	25.00	30,50	38.00	50,93	49,79	55.00	38.00
800-006-0036	HTD 36-5M-25	36	6F	25.00	30,50	38.00	57,3	56,16	62.00	38.00
800-006-0040	HTD 40-5M-25	40	6F	25.00	30,50	38.00	63,66	62,52	67.00	38.00
800-006-0044	HTD 44-5M-25	44	6W	25.00	30,50	40.00	70,03	68,89	-	38.00
800-006-0048	HTD 48-5M-25	48	6W	25.00	30,50	40.00	76,39	75,25	-	45.00
800-006-0060	HTD 60-5M-25	60	6W	25.00	30,50	40.00	95,49	94,35	-	45.00
800-006-0072	HTD 72-5M-25	72	6W	25.00	30,50	40.00	114,59	113,45	-	45.00

5mm Teilung

Vorgebohrt / Zentriert

Material:

bis Zähnezahl (ZZ) 40 in Stahl

ab Zähnezahl (ZZ) 44 in Aluminium

\*Zahnriemenbreite



www.GG-ANTRIEBSTECHNIK.DE

# Zahnriemenscheiben

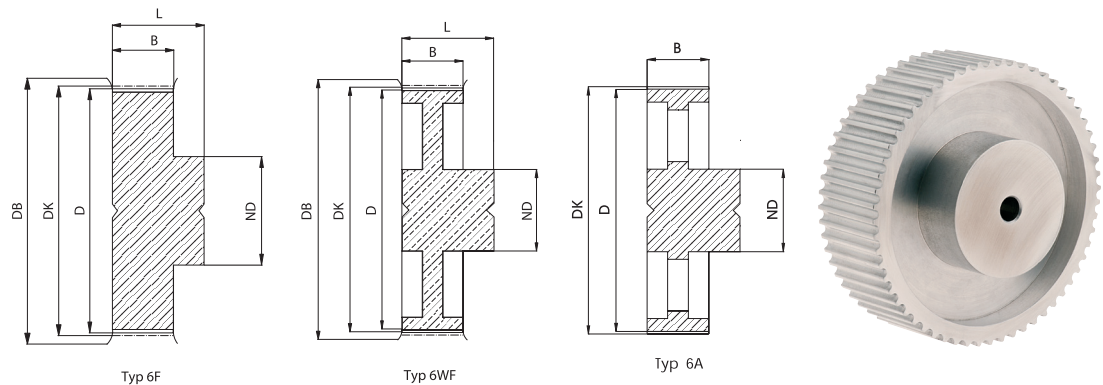

## Zahnriemenscheiben HTD 8M

G&G-Best.-Nr.	Typ	ZZ	Ausführung	ZRB*	B	L	DK	D	DB	ND
800-007-0022	HTD 22-8M-20	22	6F	20,00	28,00	38,00	56,02	54,65	62,00	43,00
800-007-0024	HTD 24-8M-20	24	6F	20,00	28,00	38,00	61,12	59,74	67,00	45,00
800-007-0026	HTD 26-8M-20	26	6F	20,00	28,00	38,00	66,21	64,84	73,00	48,00
800-007-0028	HTD 28-8M-20	28	6F	20,00	28,00	38,00	71,30	69,93	77,00	50,00
800-007-0030	HTD 30-8M-20	30	6F	20,00	28,00	38,00	76,39	75,02	84,00	55,00
800-007-0032	HTD 32-8M-20	32	6F	20,00	28,00	38,00	84,49	80,12	88,00	60,00
800-007-0034	HTD 34-8M-20	34	6F	20,00	28,00	38,00	86,58	85,21	94,00	70,00
800-007-0036	HTD 36-8M-20	36	6F	20,00	28,00	38,00	91,67	90,30	98,00	75,00
800-007-0038	HTD 38-8M-20	38	6F	20,00	28,00	38,00	96,77	95,39	104,00	75,00
800-007-0040	HTD 40-8M-20	40	6F	20,00	28,00	38,00	101,86	100,49	108,00	75,00
800-007-0044	HTD 44-8M-20	44	6F	20,00	28,00	38,00	112,05	110,67	121,00	75,00
800-007-0048	HTD 48-8M-20	48	6F	20,00	28,00	38,00	122,23	120,86	129,00	75,00
800-007-0056	HTD 56-8M-20	56	6WF	20,00	28,00	38,00	142,60	141,23	149,00	80,00
800-007-0064	HTD 64-8M-20	64	6WF	20,00	28,00	38,00	162,97	161,60	168,00	80,00
800-007-0072	HTD 72-8M-20	72	6WF	20,00	28,00	38,00	183,35	181,97	191,00	80,00
800-007-0080	HTD 80-8M-20	80	6A	20,00	28,00	38,00	203,72	202,35	-	90,00
800-007-0090	HTD 90-8M-20	90	6A	20,00	28,00	38,00	229,18	227,91	-	90,00
800-007-0112	HTD 112-8M-20	112	6A	20,00	28,00	38,00	285,21	283,83	-	90,00
800-007-0144	HTD 144-8M-20	144	6A	20,00	28,00	38,00	366,69	365,32	-	90,00
800-007-0168	HTD 168-8M-20	168	6A	20,00	28,00	38,00	427,81	426,42	-	100,00
800-007-0192	HTD 192-8M-20	192	6A	20,00	28,00	38,00	488,92	487,54	-	100,00

8mm Teilung

Vorgebohrt / Zentriert

Material:

bis Zähnezahl (ZZ) 72 in Stahl

ab Zähnezahl (ZZ) 80 in Grauguss

\*Zahnriemenbreite



www.GG-ANTRIEBSTECHNIK.DE

# Zahnriemenscheiben

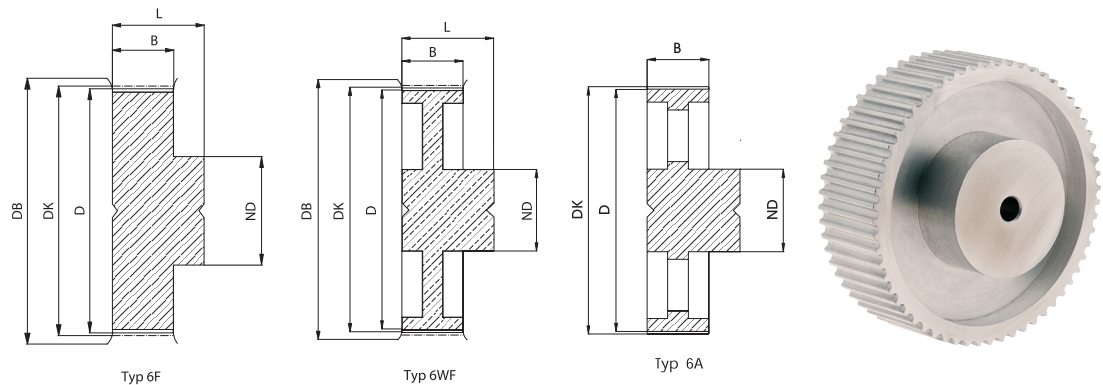

## Zahnriemenscheiben HTD 8M

G&G-Best.-Nr.	Typ	ZZ	Ausführung	ZRB*	B	L	DK	D	DB	ND
800-008-0022	HTD 22-8M-30	22	6F	30,00	38,00	48,00	56,02	54,65	62,00	43,00
800-008-0024	HTD 24-8M-30	24	6F	30,00	38,00	48,00	61,12	59,74	67,00	45,00
800-008-0026	HTD 26-8M-30	26	6F	30,00	38,00	48,00	66,21	64,84	73,00	48,00
800-008-0028	HTD 28-8M-30	28	6F	30,00	38,00	48,00	71,30	69,93	77,00	50,00
800-008-0030	HTD 30-8M-30	30	6F	30,00	38,00	48,00	76,39	75,02	84,00	55,00
800-008-0032	HTD 32-8M-30	32	6F	30,00	38,00	48,00	84,49	80,12	88,00	60,00
800-008-0034	HTD 34-8M-30	34	6F	30,00	38,00	48,00	86,58	85,21	94,00	70,00
800-008-0036	HTD 36-8M-30	36	6F	30,00	38,00	48,00	91,67	90,30	98,00	75,00
800-008-0038	HTD 38-8M-30	38	6F	30,00	38,00	48,00	96,77	95,39	104,00	75,00
800-008-0040	HTD 40-8M-30	40	6F	30,00	38,00	48,00	101,86	100,49	108,00	75,00
800-008-0044	HTD 44-8M-30	44	6F	30,00	38,00	48,00	112,05	110,67	121,00	75,00
800-008-0048	HTD 48-8M-30	48	6F	30,00	38,00	48,00	122,23	120,86	129,00	75,00
800-008-0056	HTD 56-8M-30	56	6WF	30,00	38,00	48,00	142,60	141,23	149,00	90,00
800-008-0064	HTD 64-8M-30	64	6WF	30,00	38,00	48,00	162,97	161,60	168,00	90,00
800-008-0072	HTD 72-8M-30	72	6WF	30,00	38,00	48,00	183,35	181,97	191,00	95,00
800-008-0080	HTD 80-8M-30	80	6A	30,00	38,00	48,00	203,72	202,35	-	100,00
800-008-0090	HTD 90-8M-30	90	6A	30,00	38,00	48,00	229,18	227,91	-	100,00
800-008-0112	HTD 112-8M-30	112	6A	30,00	38,00	48,00	285,21	283,83	-	100,00
800-008-0144	HTD 144-8M-30	144	6A	30,00	38,00	48,00	366,69	365,32	-	100,00
800-008-0168	HTD 168-8M-30	168	6A	30,00	38,00	48,00	427,81	426,42	-	100,00
800-008-0192	HTD 192-8M-30	192	6A	30,00	38,00	48,00	488,92	487,54	-	100,00

8mm Teilung

Vorgebohrt / Zentriert

Material:

bis Zähnezahl (ZZ) 72 in Stahl

ab Zähnezahl (ZZ) 80 in Grauguss

\*Zahnriemenbreite



www.GG-ANTRIEBSTECHNIK.DE

# Zahnriemenscheiben

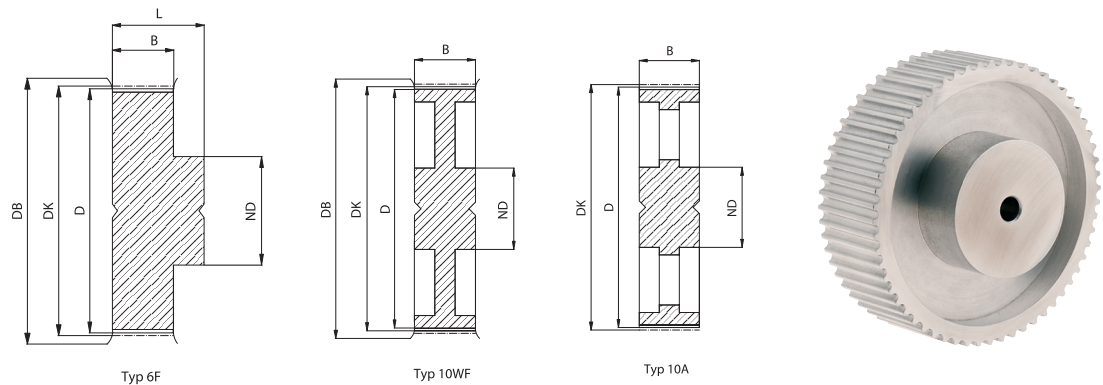

## Zahnriemenscheiben HTD 8M

G&G-Best.-Nr.	Typ	ZZ	Ausführung	ZRB*	B	L	DK	D	DB	ND
800-009-0022	HTD 22-8M-50	22	6F	50,00	60,00	70,00	56,02	54,65	62,00	43,00
800-009-0024	HTD 24-8M-50	24	6F	50,00	60,00	70,00	61,12	59,74	67,00	45,00
800-009-0026	HTD 26-8M-50	26	6F	50,00	60,00	70,00	66,21	64,84	73,00	48,00
800-009-0028	HTD 28-8M-50	28	6F	50,00	60,00	70,00	71,30	69,93	77,00	50,00
800-009-0030	HTD 30-8M-50	30	6F	50,00	60,00	70,00	76,39	75,02	84,00	55,00
800-009-0032	HTD 32-8M-50	32	6F	50,00	60,00	70,00	84,49	80,12	88,00	60,00
800-009-0034	HTD 34-8M-50	34	6F	50,00	60,00	70,00	86,58	85,21	94,00	66,00
800-009-0036	HTD 36-8M-50	36	6F	50,00	60,00	70,00	91,67	90,30	98,00	70,00
800-009-0038	HTD 38-8M-50	38	6F	50,00	60,00	70,00	96,77	95,39	104,00	75,00
800-009-0040	HTD 40-8M-50	40	6F	50,00	60,00	70,00	101,86	100,49	108,00	75,00
800-009-0044	HTD 44-8M-50	44	6F	50,00	60,00	70,00	112,05	110,67	121,00	75,00
800-009-0048	HTD 48-8M-50	48	6F	50,00	60,00	70,00	122,23	120,86	129,00	80,00
800-009-0056	HTD 56-8M-50	56	10WF	50,00	60,00	60,00	142,60	141,23	149,00	90,00
800-009-0064	HTD 64-8M-50	64	10WF	50,00	60,00	60,00	162,97	181,97	168,00	100,00
800-009-0072	HTD 72-8M-50	72	10WF	50,00	60,00	60,00	183,35	202,35	191,00	100,00
800-009-0080	HTD 80-8M-50	80	10A	50,00	60,00	60,00	203,72	227,91	-	110,00
800-009-0090	HTD 90-8M-50	90	10A	50,00	60,00	60,00	229,18	227,91	-	110,00
800-009-0112	HTD 112-8M-50	112	10A	50,00	60,00	60,00	285,21	283,83	-	110,00
800-009-0144	HTD 144-8M-50	144	10A	50,00	60,00	60,00	366,69	365,32	-	110,00
800-009-0168	HTD 168-8M-50	168	10A	50,00	60,00	60,00	427,81	426,42	-	120,00
800-009-0192	HTD 192-8M-50	192	10A	50,00	60,00	60,00	488,92	487,54	-	130,00

8mm Teilung

Vorgebohrt / Zentriert

Material:

bis Zähnezahl (ZZ) 72 in Stahl

ab Zähnezahl (ZZ) 80 in Grauguss

\*Zahnriemenbreite



www.GG-ANTRIEBSTECHNIK.DE

# Zahnriemenscheiben

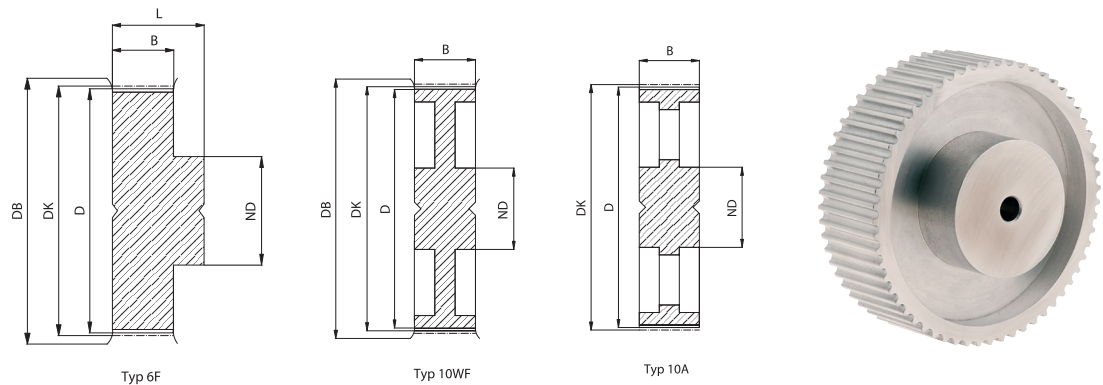

## Zahnriemenscheiben HTD 8M

G&G-Best.-Nr.	Typ	ZZ	Ausführung	ZRB*	B	L	DK	D	DB	ND
800-010-0022	HTD 22-8M-85	22	6F	85,00	95,00	105,00	56,02	54,65	62,00	43,00
800-010-0024	HTD 24-8M-85	24	6F	85,00	95,00	105,00	61,12	59,74	67,00	45,00
800-010-0026	HTD 26-8M-85	26	6F	85,00	95,00	105,00	66,21	64,84	73,00	48,00
800-010-0028	HTD 28-8M-85	28	6F	85,00	95,00	105,00	71,30	69,93	77,00	50,00
800-010-0030	HTD 30-8M-85	30	6F	85,00	95,00	105,00	76,39	75,02	84,00	55,00
800-010-0032	HTD 32-8M-85	32	6F	85,00	95,00	105,00	84,49	80,12	88,00	60,00
800-010-0034	HTD 34-8M-85	34	6F	85,00	95,00	105,00	86,58	85,21	94,00	66,00
800-010-0036	HTD 36-8M-85	36	6F	85,00	95,00	105,00	91,67	90,30	98,00	70,00
800-010-0038	HTD 38-8M-85	38	6F	85,00	95,00	105,00	96,77	95,39	104,00	75,00
800-010-0040	HTD 40-8M-85	40	6F	85,00	95,00	105,00	101,86	100,49	108,00	75,00
800-010-0044	HTD 44-8M-85	44	6F	85,00	95,00	105,00	112,05	110,67	121,00	75,00
800-010-0048	HTD 48-8M-85	48	6F	85,00	95,00	105,00	122,23	120,86	129,00	80,00
800-010-0056	HTD 56-8M-85	56	6F	85,00	95,00	105,00	142,60	141,23	149,00	90,00
800-010-0064	HTD 64-8M-85	64	10WF	85,00	95,00	95,00	162,97	161,60	168,00	100,00
800-010-0072	HTD 72-8M-85	72	10WF	85,00	95,00	95,00	183,35	181,97	191,00	100,00
800-010-0080	HTD 80-8M-85	80	10A	85,00	95,00	95,00	203,72	202,35	-	110,00
800-010-0090	HTD 90-8M-85	90	10A	85,00	95,00	95,00	229,18	227,91	-	110,00
800-010-0112	HTD 112-8M-85	112	10A	85,00	95,00	95,00	285,21	283,83	-	110,00
800-010-0144	HTD 144-8M-85	144	10A	85,00	95,00	95,00	366,69	365,32	-	110,00
800-010-0168	HTD 168-8M-85	168	10A	85,00	95,00	95,00	427,81	426,42	-	120,00
800-010-0192	HTD 192-8M-85	192	10A	85,00	95,00	95,00	488,92	487,54	-	130,00

8mm Teilung

Vorgebohrt / Zentriert

Material:

bis Zähnezahl (ZZ) 72 in Stahl

ab Zähnezahl (ZZ) 80 in Grauguss

\*Zahnriemenbreite



www.GG-ANTRIEBSTECHNIK.DE

# Zahnriemenscheiben

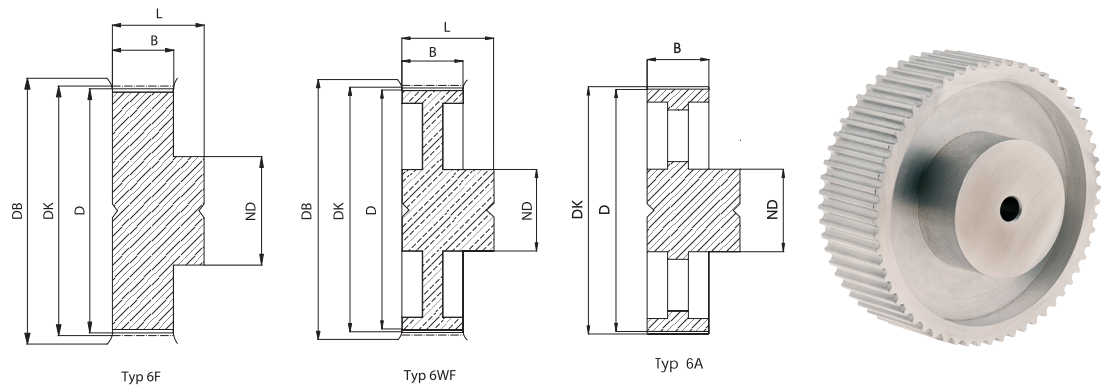

## Zahnriemenscheiben HTD 14M

G&G-Best.-Nr.	Typ	ZZ	Ausführung	ZRB*	B	L	DK	D	DB	ND
800-011-0028	HTD 28-14M-40	28	6F	40.00	54.00	69.00	124,78	121,98	128.00	100.00
800-011-0029	HTD 29-14M-40	29	6F	40.00	54.00	69.00	129,23	126,44	138.00	100.00
800-011-0030	HTD 30-14M-40	30	6F	40.00	54.00	69.00	133,69	130,9	138.00	100.00
800-011-0032	HTD 32-14M-40	32	6F	40.00	54.00	69.00	142,60	139,81	154.00	100.00
800-011-0034	HTD 34-14M-40	34	6F	40.00	54.00	69.00	151,52	148,72	160.00	100.00
800-011-0036	HTD 36-14M-40	36	6F	40.00	54.00	69.00	160,43	157,63	168.00	100.00
800-011-0038	HTD 38-14M-40	38	6F	40.00	54.00	69.00	169,34	166,55	184.00	120.00
800-011-0040	HTD 40-14M-40	40	6F	40.00	54.00	69.00	178,25	175,46	188.00	120.00
800-011-0044	HTD 44-14M-40	44	6F	40.00	54.00	69.00	196,08	193,28	212.00	120.00
800-011-0048	HTD 48-14M-40	48	6WF	40.00	54.00	69.00	213,90	211,11	226.00	135.00
800-011-0056	HTD 56-14M-40	56	6WF	40.00	54.00	69.00	249,55	246,76	256.00	135.00
800-011-0064	HTD 64-14M-40	64	6WF	40.00	54.00	69.00	285,21	282,41	296.00	135.00
800-011-0072	HTD 72-14M-40	72	6A	40.00	54.00	69.00	320,86	318,06	-	135.00
800-011-0080	HTD 80-14M-40	80	6A	40.00	54.00	69.00	356,51	353,71	-	135.00
800-011-0090	HTD 90-14M-40	90	6A	40.00	54.00	69.00	401,07	398,28	-	135.00
800-011-0112	HTD 112-14M-40	112	6A	40.00	54.00	69.00	499,11	496,32	-	135.00
800-011-0144	HTD 144-14M-40	144	6A	40.00	54.00	69.00	641,71	638,92	-	135.00

14mm Teilung

Vorgebohrt / Zentriert

Material:

bis Zähnezahl (ZZ) 44 in Stahl

ab Zähnezahl (ZZ) 48 in Grauguss

\*Zahnriemenbreite



www.GG-ANTRIEBSTECHNIK.DE

# Zahnriemenscheiben

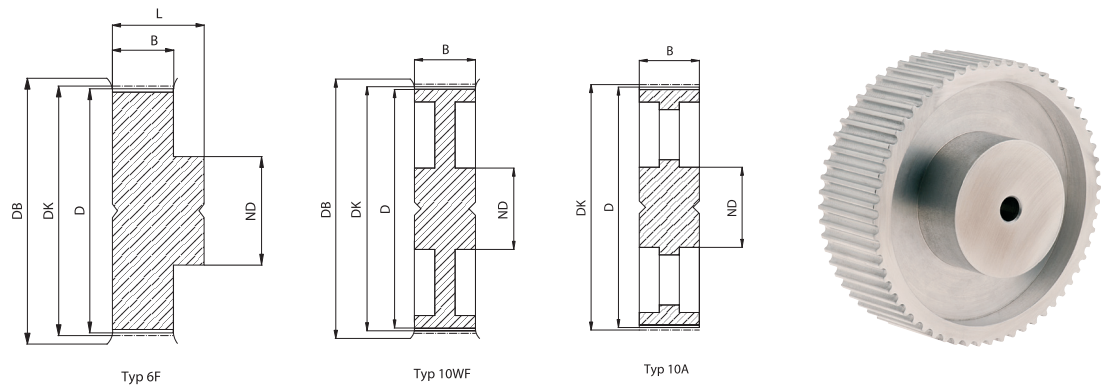

## Zahnriemenscheiben HTD 14M

G&G-Best.-Nr.	Typ	ZZ	Ausführung	ZRB*	B	L	DK	D	DB	ND
800-012-0028	HTD 28-14M-55	28	6F	55.00	70.00	85.00	124,78	121,98	128.00	100.00
800-012-0029	HTD 29-14M-55	29	6F	55.00	70.00	85.00	129,23	126,44	138.00	100.00
800-012-0030	HTD 30-14M-55	30	6F	55.00	70.00	85.00	133,69	130,9	138.00	100.00
800-012-0032	HTD 32-14M-55	32	6F	55.00	70.00	85.00	142,60	139,81	154.00	100.00
800-012-0034	HTD 34-14M-55	34	6F	55.00	70.00	85.00	151,52	148,72	160.00	100.00
800-012-0036	HTD 36-14M-55	36	6F	55.00	70.00	85.00	160,43	157,63	168.00	100.00
800-012-0038	HTD 38-14M-55	38	6F	55.00	70.00	85.00	169,34	166,55	184.00	120.00
800-012-0040	HTD 40-14M-55	40	6F	55.00	70.00	85.00	178,25	175,46	188.00	120.00
800-012-0044	HTD 44-14M-55	44	6F	55.00	70.00	85.00	196,08	193,28	212.00	120.00
800-012-0048	HTD 48-14M-55	48	10WF	55.00	70.00	70.00	213,9	211,11	226.00	135.00
800-012-0056	HTD 56-14M-55	56	10WF	55.00	70.00	70.00	249,55	246,76	256.00	135.00
800-012-0064	HTD 64-14M-55	64	10WF	55.00	70.00	70.00	285,21	282,41	296.00	135.00
800-012-0072	HTD 72-14M-55	72	10A	55.00	70.00	70.00	320,86	318,06	-	135.00
800-012-0080	HTD 80-14M-55	80	10A	55.00	70.00	70.00	356,51	353,71	-	135.00
800-012-0090	HTD 90-14M-55	90	10A	55.00	70.00	70.00	401,07	398,28	-	135.00
800-012-0112	HTD 112-14M-55	112	10A	55.00	70.00	70.00	499,11	496,32	-	135.00
800-012-0144	HTD 144-14M-55	144	10A	55.00	70.00	70.00	641,71	638,92	-	135.00

14mm Teilung

Vorgebohrt / Zentriert

Material:

bis Zähnezahl (ZZ) 44 in Stahl

ab Zähnezahl (ZZ) 48 in Grauguss

\*Zahnriemenbreite





www.GG-ANTRIEBSTECHNIK.DE

# Zahnriemenscheiben

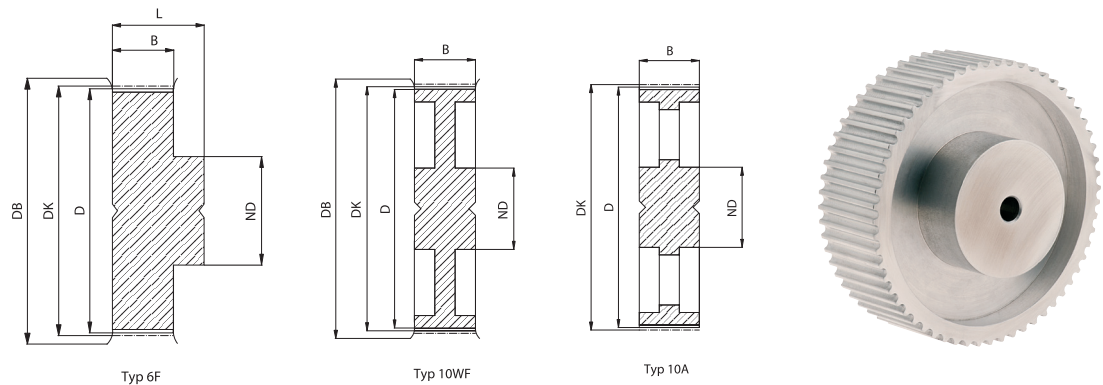

## Zahnriemenscheiben HTD 14M

G&G-Best.-Nr.	Typ	ZZ	Ausführung	ZRB*	B	L	DK	D	DB	ND
800-013-0028	HTD 28-14M-85	28	6F	85.00	102.00	117.00	124,78	121,98	128.00	100.00
800-013-0029	HTD 29-14M-85	29	6F	85.00	102.00	117.00	129,23	126,44	138.00	100.00
800-013-0030	HTD 30-14M-85	30	6F	85.00	102.00	117.00	133,69	130,9	138.00	100.00
800-013-0032	HTD 32-14M-85	32	6F	85.00	102.00	117.00	142,60	139,81	154.00	100.00
800-013-0034	HTD 34-14M-85	34	6F	85.00	102.00	117.00	151,52	148,72	160.00	100.00
800-013-0036	HTD 36-14M-85	36	6F	85.00	102.00	117.00	160,43	157,63	168.00	100.00
800-013-0038	HTD 38-14M-85	38	6F	85.00	102.00	117.00	169,34	166,55	184.00	120.00
800-013-0040	HTD 40-14M-85	40	6F	85.00	102.00	117.00	178,25	175,46	188.00	135.00
800-013-0044	HTD 44-14M-85	44	6F	85.00	102.00	117.00	196,08	193,28	212.00	135.00
800-013-0048	HTD 48-14M-85	48	6F	85.00	102.00	117.00	213,9	211,11	226.00	150.00
800-013-0056	HTD 56-14M-85	56	10WF	85.00	102.00	102.00	249,55	246,76	256.00	150.00
800-013-0064	HTD 64-14M-85	64	10WF	85.00	102.00	102.00	285,21	282,41	296.00	150.00
800-013-0072	HTD 72-14M-85	72	10A	85.00	102.00	102.00	320,86	318,06	-	150.00
800-013-0080	HTD 80-14M-85	80	10A	85.00	102.00	102.00	356,51	353,71	-	150.00
800-013-0090	HTD 90-14M-85	90	10A	85.00	102.00	102.00	401,07	398,28	-	150.00
800-013-0112	HTD 112-14M-85	112	10A	85.00	102.00	102.00	499,11	496,32	-	150.00
800-013-0144	HTD 144-14M-85	144	10A	85.00	102.00	102.00	641,71	638,92	-	150.00

14mm Teilung

Vorgebohrt / Zentriert

Material:

bis Zähnezahl (ZZ) 48 in Stahl

ab Zähnezahl (ZZ) 56 in Grauguss

\*Zahnriemenbreite



www.GG-ANTRIEBSTECHNIK.DE

# Zahnriemenscheiben

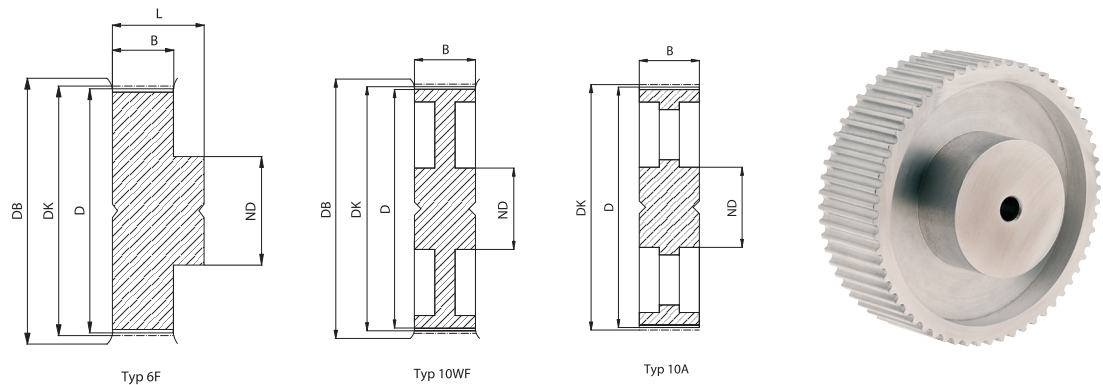

## Zahnriemenscheiben HTD 14M

G&G-Best.-Nr.	Typ	ZZ	Ausführung	ZRB*	B	L	DK	D	DB	ND
800-014-0028	HTD 28-14M-115	28	6F	115.00	133.00	148.00	124,78	121,98	128,00	100.00
800-014-0029	HTD 29-14M-115	29	6F	115.00	133.00	148.00	129,23	126,44	138.00	100.00
800-014-0030	HTD 30-14M-115	30	6F	115.00	133.00	148.00	133,69	130,9	138.00	100.00
800-014-0032	HTD 32-14M-115	32	6F	115.00	133.00	148.00	142,60	139,81	154.00	100.00
800-014-0034	HTD 34-14M-115	34	6F	115.00	133.00	148.00	151,52	148,72	160.00	100.00
800-014-0036	HTD 36-14M-115	36	6F	115.00	133.00	148.00	160,43	157,63	168.00	100.00
800-014-0038	HTD 38-14M-115	38	6F	115.00	133.00	148.00	169,34	166,55	184.00	120.00
800-014-0040	HTD 40-14M-115	40	6F	115.00	133.00	148.00	178,25	175,46	188.00	135.00
800-014-0044	HTD 44-14M-115	44	6F	115.00	133.00	148.00	196,08	193,28	212.00	150.00
800-014-0048	HTD 48-14M-115	48	6F	115.00	133.00	148.00	213,9	211,11	226.00	150.00
800-014-0056	HTD 56-14M-115	56	6F	115.00	133.00	148.00	249,55	246,76	256.00	150.00
800-014-0064	HTD 64-14M-115	64	10WF	115.00	133.00	133.00	285,21	282,41	296.00	150.00
800-014-0072	HTD 72-14M-115	72	10A	115.00	133.00	133.00	320,86	318,06	-	150.00
800-014-0080	HTD 80-14M-115	80	10A	115.00	133.00	133.00	356,51	353,71	-	150.00
800-014-0090	HTD 90-14M-115	90	10A	115.00	133.00	133.00	401,07	398,28	-	150.00
800-014-0112	HTD 112-14M-115	112	10A	115.00	133.00	133.00	499,11	496,32	-	150.00
800-014-0144	HTD 144-14M-115	144	10A	115.00	133.00	133.00	641,71	638,92	-	165.00

14mm Teilung

Vorgebohrt / Zentriert

Material:

bis Zähnezahl (ZZ) 56 in Stahl

ab Zähnezahl (ZZ) 64 in Grauguss

\*Zahnriemenbreite



www.GG-ANTRIEBSTECHNIK.DE

# Zahnriemenscheiben

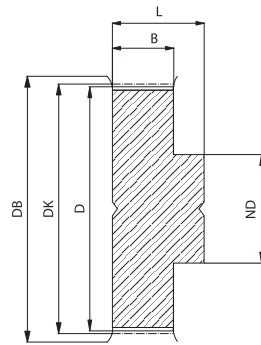

Typ 6F

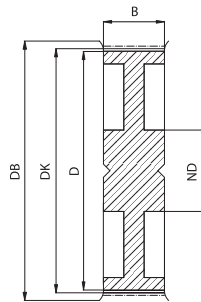

Typ 10WF

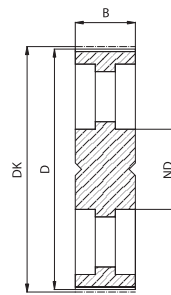

Typ 10A

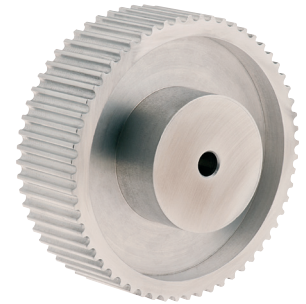

## Zahnriemenscheiben HTD 14M

G&G-Best.-Nr.	Typ	ZZ	Ausführung	ZRB*	B	L	DK	D	DB	ND
800-015-0028	HTD 28-14M-170	28	6F	170.00	187.00	202.00	124,78	121,98	128.00	100.00
800-015-0029	HTD 29-14M-170	29	6F	170.00	187.00	202.00	129,23	126,44	138.00	100.00
800-015-0030	HTD 30-14M-170	30	6F	170.00	187.00	202.00	133,69	130,9	138.00	100.00
800-015-0032	HTD 32-14M-170	32	6F	170.00	187.00	202.00	142,60	139,81	154.00	100.00
800-015-0034	HTD 34-14M-170	34	6F	170.00	187.00	202.00	151,52	148,72	160.00	100.00
800-015-0036	HTD 36-14M-170	36	6F	170.00	187.00	202.00	160,43	157,63	168.00	100.00
800-015-0038	HTD 38-14M-170	38	6F	170.00	187.00	202.00	169,34	166,55	184.00	120.00
800-015-0040	HTD 40-14M-170	40	6F	170.00	187.00	202.00	178,25	175,46	188.00	135.00
800-015-0044	HTD 44-14M-170	44	6F	170.00	187.00	202.00	196,08	193,28	212.00	190.00
800-015-0048	HTD 48-14M-170	48	6F	170.00	187.00	202.00	213,9	211,11	226.00	150.00
800-015-0056	HTD 56-14M-170	56	6F	170.00	187.00	202.00	249,55	246,76	256.00	150.00
800-015-0064	HTD 64-14M-170	64	6F	170.00	187.00	202.00	285,21	282,41	296.00	150.00
800-015-0072	HTD 72-14M-170	72	10WF	170.00	187.00	187.00	320,86	318,06	-	150.00
800-015-0080	HTD 80-14M-170	80	10WF	170.00	187.00	187.00	356,51	353,71	-	150.00
800-015-0090	HTD 90-14M-170	90	10A	170.00	187.00	187.00	401,07	398,28	-	150.00
800-015-0112	HTD 112-14M-170	112	10A	170.00	187.00	187.00	499,11	496,32	-	150.00
800-015-0144	HTD 144-14M-170	144	10A	170.00	187.00	187.00	641,71	638,92	-	165.00

14mm Teilung

Vorgebohrt / Zentriert

Material:

bis Zähnezahl (ZZ) 64 in Stahl

ab Zähnezahl (ZZ) 72 in Grauguss

\*Zahnriemenbreite