

Rollenketten

Rollenketten ISO Simplex

Rollenketten ISO Duplex

Rollenketten ISO Triplex

Rollenketten ASA Simplex

Sonderanfertigungen nach Zeichnung sowie
Standardteile einbaufertig bearbeitet,
auf Wunsch mit Wärme- und/oder Oberflächenbehandlung

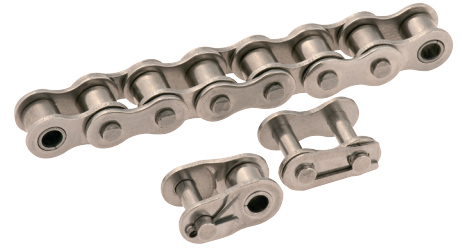
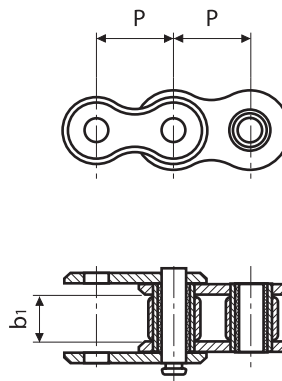

Rollenketten ISO Simplex

Rollenkette G&G-Bestell-Nr.	Verschlussglied G&G-Bestell-Nr.	Verschlussglied - gekröpft G&G-Bestell-Nr.	ISO Nr.	(pxb) inch	(pxb) mm
600-061-0000	-0001	-0041	04 B-1		6 x 2,8mm
600-081-0000	-0001	-0041	05 B-1		8 x 3mm
600-101-0000	-0001	-0041	06 B-1	3/8 x 7/32"	9,525 x 5,72mm
600-211-0000	-0001	-0041	081-1	1/2 x 1/8"	12,7 x 3,3mm
600-231-0000	-0001	-0041	083-1	1/2 x 3/16"	12,7 x 4,88mm
600-201-0000	-0001	-0041	08 B-1	1/2 x 5/16"	12,7 x 7,75mm
600-301-0000	-0001	-0041	10 B-1	5/8 x 3/8"	15,875 x 9,65mm
600-401-0000	-0001	-0041	12 B-1	3/4 x 7/16"	19,05 x 11,68mm
600-501-0000	-0001	-0041	16 B-1	1" x 17,02mm	25,4 x 17,02mm
600-601-0000	-0001	-0041	20 B-1	1 1/4 x 3/4"	31,75 x 19,56mm
600-701-0000	-0001	-0041	24 B-1	1 1/2 x 1"	38,1 x 25,4mm
600-751-0000	-0001	-0041	28 B-1	1 3/4 x 1 1/4"	44,45 x 30,99mm
600-801-0000	-0001	-0041	32 B-1	2 x 1 1/4"	50,8 x 30,99mm
600-851-0000	-0001	-0041	40 B-1	2 1/2 x 1 1/2	63,5 x 38,1mm
600-901-0000	-0001	-0041	48 B-1	3 x 1 3/4"	76,2 x 45,72mm

Rollenkette DIN 8187
ISO Simplex

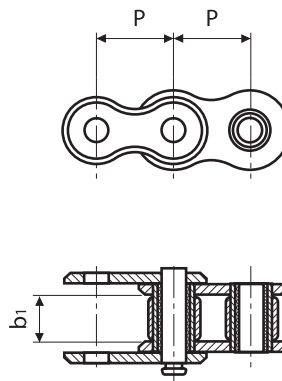

Rollenketten ISO Simplex rostfrei

Rollenkette G&G-Bestell-Nr.	Verschlussglied GG-Bestell-Nr.	Verschlussglied gekröpft GG-Bestell-Nr.	ISO Nr.	(pxb) inch	(pxb) mm
600-081-0600	-0601	-0641	05 B-1		8 x 3mm
600-101-0600	-0601	-0641	06 B-1	3/8 x 7/32"	9,525 x 5,72mm
600-201-0600	-0601	-0641	08 B-1	1/2 x 5/16"	12,7 x 7,75mm
600-301-0600	-0601	-0641	10 B-1	5/8 x 3/8"	15,875 x 9,65mm
600-401-0600	-0601	-0641	12 B-1	3/4 x 7/16"	19,05 x 11,68mm
600-501-0600	-0601	-0641	16 B-1	1" x 17,02mm	25,4 x 17,02mm

Rollenkette DIN 8187
ISO Simplex rostfrei

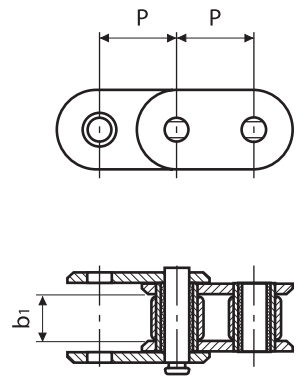

Rollenketten ISO Simplex gerade Laschen

Rollenkette G&G-Bestell-Nr.	Verschlussglied GG-Bestell-Nr.	Verschlussglied - gekröpft GG-Bestell-Nr.	ISO Nr.	(pxb) inch	(pxb) mm
610-201-0000	-0001	-0041	08 B-1 GL	1/2"x5/16"	12,7x7,75mm
610-301-0000	-0001	-0041	10 B-1 GL	5/8"x3/8"	15,875x9,65mm
610-401-0000	-0001	-0041	12 B-1 GL	3/4"x7/16"	19,05x11,68mm
610-501-0000	-0001	-0041	16 B-1 GL	1"x17,02	25,4x17,02mm
610-601-0000	-0001	-0041	20 B-1 GL	1 1/4"x3/4"	31,75x19,56mm
610-701-0000	-0001	-0041	24 B-1 GL	1 1/2"x1"	38,1x25,4mm

Rollenkette DIN 8187
ISO Simplex gerade Laschen

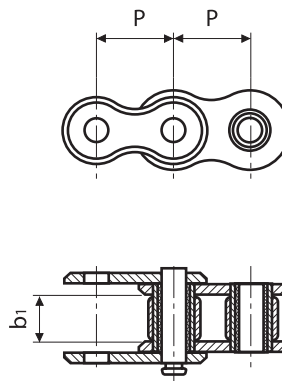

Rollenketten ISO Simplex galvanisch vernickelt

Rollenkette G&G-Bestell-Nr.	Verschlussglied GG-Bestell-Nr.	Verschlussglied - gekröpft GG-Bestell-Nr.	ISO Nr.	(pxb) inch	(pxb) mm
630-081-0000	-0001	-0041	05 B-1 NI	8x3mm	8x3mm
630-101-0000	-0001	-0041	06 B-1 NI	3/8" x 7/32"	15,875x9,65mm
630-201-0000	-0001	-0041	08 B-1 NI	1/2" x 5/16"	12,7x7,75mm
630-301-0000	-0001	-0041	10 B-1 NI	5/8" x 3/8"	15,875x9,65mm
630-401-0000	-0001	-0041	12 B-1 NI	3/4" x 7/16"	19,05x11,68mm
630-501-0000	-0001	-0041	16 B-1 NI	1" x 17,02	25,4x17,02mm
630-601-0000	-0001	-0041	20 B-1 NI	1 1/4" x 3/4"	31,75x19,56mm

Rollenkette DIN 8187
ISO Simplex galvanisch vernickelt

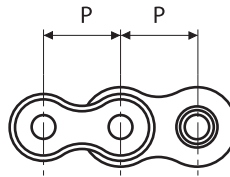
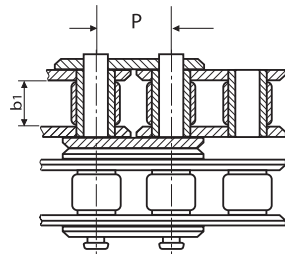

Rollenketten ISO Duplex

Rollenkette G&G-Bestell-Nr.	Verschlussglied GG-Bestell-Nr.	Verschlussglied - gekröpft GG-Bestell-Nr.:	ISO Nr.	(pxb) inch	(pxb) mm
600-082-0000	-0001	-0041	05 B-2		8 x 3mm
600-102-0000	-0001	-0041	06 B-2	3/8 x 7/32"	9,525 x 5,72mm
600-202-0000	-0001	-0041	08 B-2	1/2 x 5/16"	12,7 x 7,75mm
600-302-0000	-0001	-0041	10 B-2	5/8 x 3/8"	15,875 x 9,65mm
600-402-0000	-0001	-0041	12 B-2	3/4 x 7/16"	19,05 x 11,68mm
600-502-0000	-0001	-0041	16 B-2	1" x 17,02mm	25,4 x 17,02mm
600-602-0000	-0001	-0041	20 B-2	1 1/4 x 3/4"	31,75 x 19,56mm
600-702-0000	-0001	-0041	24 B-2	1 1/2 x 1"	38,1 x 25,4mm
600-752-0000	-0001	-0041	28 B-2	1 3/4 x 1 1/4"	44,45 x 30,99mm
600-802-0000	-0001	-0041	32 B-2	2 x 1 1/4"	50,8 x 30,99mm
600-852-0000	-0001	-0041	40 B-2	2 1/2 x 1 1/2"	63,5 x 38,1mm
600-902-0000	-0001	-0041	48 B-2	3 x 1 3/4"	76,2 x 45,72mm

Rollenkette DIN 8187
ISO Duplex

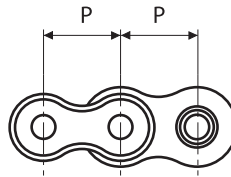
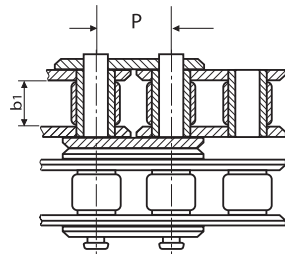

Rollenketten ISO Duplex rostfrei

Rollenkette G&G-Bestell-Nr.	Verschlussglied GG-Bestell-Nr.	Verschlussglied - gekröpft GG-Bestell-Nr.	ISO Nr.	(pxb) inch	(pxb) mm
600-102-0600	-0001	-0041	06 B-2	3/8 x 7/32"	9,525 x 5,72mm
600-202-0600	-0001	-0041	08 B-2	1/2 x 5/16"	12,7 x 7,75mm
600-302-0600	-0001	-0041	10 B-2	5/8 x 3/8"	15,875 x 9,65mm
600-402-0600	-0001	-0041	12 B-2	3/4 x 7/16"	19,05 x 11,68mm
600-502-0600	-0001	-0041	16 B-2	1" x 17,02mm	25,4 x 17,02mm

Rollenkette DIN 8187
ISO Duplex rostfrei

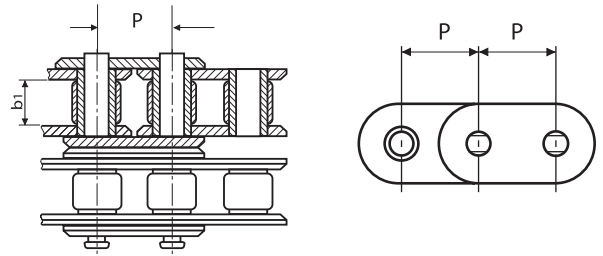

Rollenketten ISO Duplex gerade Laschen

Rollenkette G&G-Bestell-Nr.	Verschlussglied GG-Bestell-Nr.	Verschlussglied - gekröpft GG-Bestell-Nr.:	ISO Nr.	(pxb) inch	(pxb) mm
610-202-0000	-0001	-0041	08 B-2 GL	1/2" x 5/16"	12,7 x 7,75mm
610-302-0000	-0001	-0041	10 B-2 GL	5/8" x 3/8"	15,875 x 9,65mm
610-402-0000	-0001	-0041	12 B-2 GL	3/4" x 7/16"	19,05 x 11,68mm
610-502-0000	-0001	-0041	16 B-2 GL	1" x 17,02	25,4 x 17,02mm

Rollenkette DIN 8187
ISO Duplex gerade Laschen

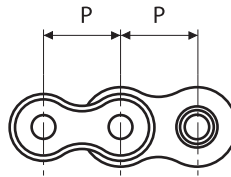
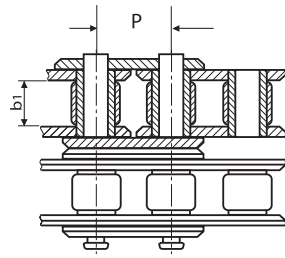

Rollenketten ISO Duplex galvanisch vernickelt

Rollenkette G&G-Bestell-Nr.	Verschlussglied GG-Bestell-Nr.	Verschlussglied - gekröpft GG-Bestell-Nr.	ISO Nr.	(pxb) inch	(pxb) mm
630-082-0000	-0001	-0041	05 B-2 NI	8x3mm	8x3mm
630-102-0000	-0001	-0041	06 B-2 NI	3/8" x 7/32"	15,875x9,65mm
630-202-0000	-0001	-0041	08 B-2 NI	1/2" x 5/16"	12,7x7,75mm
630-302-0000	-0001	-0041	10 B-2 NI	5/8" x 3/8"	15,875x9,65mm
630-402-0000	-0001	-0041	12 B-2 NI	3/4" x 7/16"	19,05x11,68mm
630-502-0000	-0001	-0041	16 B-2 NI	1" x 17,02	25,4x17,02mm

Rollenkette DIN 8187
ISO Duplex galvanisch vernickelt

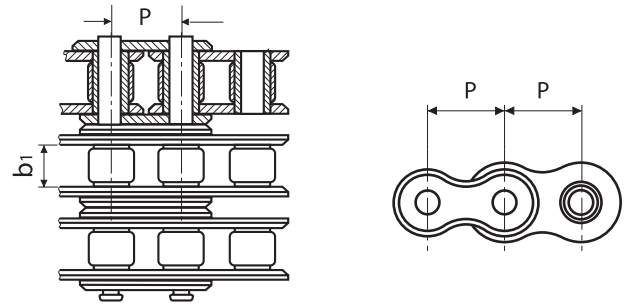

Rollenketten ISO Triplex

Rollenkette G&G-Bestell-Nr.	Verschlussglied GG-Bestell-Nr.	Verschlussglied - gekröpft GG-Bestell-Nr.	ISO Nr.	(pxb) inch	(pxb) mm
600-103-0000	-0001	-0041	06 B-3	3/8 x 7/32"	9,525 x 5,72mm
600-203-0000	-0001	-0041	08 B-3	1/2 x 5/16"	12,7 x 7,75mm
600-303-0000	-0001	-0041	10 B-3	5/8 x 3/8"	15,875 x 9,65mm
600-403-0000	-0001	-0041	12 B-3	3/4 x 7/16"	19,05 x 11,68mm
600-503-0000	-0001	-0041	16 B-3	1" x 17,02mm	25,4 x 17,02mm
600-603-0000	-0001	-0041	20 B-3	1 1/4 x 3/4"	31,75 x 19,56mm
600-703-0000	-0001	-0041	24 B-3	1 1/2 x 1"	38,1 x 25,4mm
600-753-0000	-0001	-0041	28 B-3	1 3/4 x 1 1/4"	44,45 x 30,99mm
600-803-0000	-0001	-0041	32 B-3	2 x 1 1/4"	50,8 x 30,99mm
600-853-0000	-0001	-0041	40 B-3	2 1/2 x 1 1/2"	63,5 x 38,1mm
600-903-0000	-0001	-0041	48 B-3	3 x 1 3/4"	76,2 x 45,72mm

Rollenkette DIN 8187
ISO Triplex

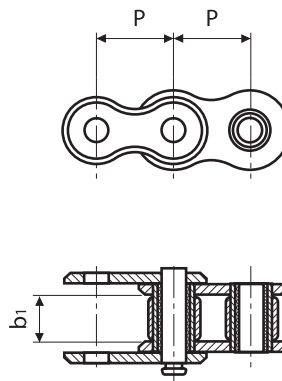

Rollenketten ASA Simplex

Rollenkette G&G-Bestell-Nr.	Verschlussglied GG-Bestell-Nr.	Verschlussglied - gekröpft GG-Bestell-Nr.	ASA Nr.	(pxb) inch	(pxb) mm
620-201-0000	-0001	-0041	08 A-1	1/2 x 5/16"	12,7 x 7,95mm
620-301-0000	-0001	-0041	10 A-1	5/8 x 3/8"	15,875 x 9,53mm
620-401-0000	-0001	-0041	12 A-1	3/4 x 1/2"	19,05 x 12,7mm
620-501-0000	-0001	-0041	16 A-1	1 x 5/8"	25,4 x 15,88mm
620-601-0000	-0001	-0041	20 A-1	1 1/4 x 3/4"	31,75 x 19,05mm
620-701-0000	-0001	-0041	24 A-1	1 1/2 x 1"	38,1 x 25,4mm
620-751-0000	-0001	-0041	28 A-1	1 3/4 x 1"	44,45 x 25,4mm
620-801-0000	-0001	-0041	32 A-1	2 x 1 1/4"	50,8 x 31,75mm

Rollenkette DIN 8188
ASA Simplex